

Local convergence in t-PNG

joint with Ruby Bestwick, Artem Borisov, Elnur Emrah, and
Jessica Jay

Márton Balázs

University of Bristol

Universality in the Kardar-Parisi-Zhang class and random
matrix theory

ICMS, Bayes Centre, Edinburgh

June 2026.

Polynuclear Growth

t-PNG

Stationary *t*-PNG

Local convergence

Ingredients

Proof

Polynuclear Growth (PNG) [Hammersley '72]

- ▶ Poisson space-time points initiate nucleations
-

Polynuclear Growth (PNG) [Hammersley '72]

- ▶ Poisson space-time points initiate nucleations
 - ▶ Nucleations spread at unit speed
-

Polynuclear Growth (PNG) [Hammersley '72]

- ▶ Poisson space-time points initiate nucleations
 - ▶ Nucleations spread at unit speed
 - ▶ They annihilate upon meeting
-

Polynuclear Growth (PNG) [Hammersley '72]

- ▶ Poisson space-time points initiate nucleations
 - ▶ Nucleations spread at unit speed
 - ▶ They annihilate upon meeting
 - ▶ \rightsquigarrow height function
-

Polynuclear Growth (PNG) [Hammersley '72]

- ▶ Poisson space-time points initiate nucleations
 - ▶ Nucleations spread at unit speed
 - ▶ They annihilate upon meeting
 - ▶ \rightsquigarrow height function
-

Polynuclear Growth (PNG) [Hammersley '72]

- ▶ Poisson space-time points initiate nucleations
 - ▶ Nucleations spread at unit speed
 - ▶ They annihilate upon meeting
 - ▶ \rightsquigarrow height function
-

Polynuclear Growth (PNG) [Hammersley '72]

- ▶ Poisson space-time points initiate nucleations
 - ▶ Nucleations spread at unit speed
 - ▶ They annihilate upon meeting
 - ▶ \rightsquigarrow height function
-

Polynuclear Growth (PNG) [Hammersley '72]

- ▶ Poisson space-time points initiate nucleations
 - ▶ Nucleations spread at unit speed
 - ▶ They annihilate upon meeting
 - ▶ \rightsquigarrow height function
-

Polynuclear Growth (PNG) [Hammersley '72]

- ▶ Poisson space-time points initiate nucleations
 - ▶ Nucleations spread at unit speed
 - ▶ They annihilate upon meeting
 - ▶ \rightsquigarrow height function
-

Polynuclear Growth (PNG) [Hammersley '72]

- ▶ Poisson space-time points initiate nucleations
 - ▶ Nucleations spread at unit speed
 - ▶ They annihilate upon meeting
 - ▶ \rightsquigarrow height function
-

Polynuclear Growth (PNG) [Hammersley '72]

- ▶ Poisson space-time points initiate nucleations
 - ▶ Nucleations spread at unit speed
 - ▶ They annihilate upon meeting
 - ▶ \rightsquigarrow height function
-

Polynuclear Growth (PNG) [Hammersley '72]

- ▶ Poisson space-time points initiate nucleations
 - ▶ Nucleations spread at unit speed
 - ▶ They annihilate upon meeting
 - ▶ \rightsquigarrow height function
-

Polynuclear Growth (PNG) [Hammersley '72]

- ▶ Poisson space-time points initiate nucleations
 - ▶ Nucleations spread at unit speed
 - ▶ They annihilate upon meeting
 - ▶ \rightsquigarrow height function
-

Polynuclear Growth (PNG) [Hammersley '72]

- ▶ Poisson space-time points initiate nucleations
 - ▶ Nucleations spread at unit speed
 - ▶ They annihilate upon meeting
 - ▶ \rightsquigarrow height function
-

Polynuclear Growth (PNG) [Hammersley '72]

- ▶ Poisson space-time points initiate nucleations
 - ▶ Nucleations spread at unit speed
 - ▶ They annihilate upon meeting
 - ▶ \rightsquigarrow height function
-

Polynuclear Growth (PNG) [Hammersley '72]

- ▶ Poisson space-time points initiate nucleations
 - ▶ Nucleations spread at unit speed
 - ▶ They annihilate upon meeting
 - ▶ \rightsquigarrow height function
-

Polynuclear Growth (PNG) [Hammersley '72]

- ▶ Poisson space-time points initiate nucleations
- ▶ Nucleations spread at unit speed
- ▶ They annihilate upon meeting
- ▶ \rightsquigarrow height function

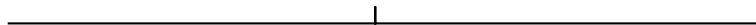

Polynuclear Growth (PNG) [Hammersley '72]

- ▶ Poisson space-time points initiate nucleations
- ▶ Nucleations spread at unit speed
- ▶ They annihilate upon meeting
- ▶ \rightsquigarrow height function



Polynuclear Growth (PNG) [Hammersley '72]

- ▶ Poisson space-time points initiate nucleations
- ▶ Nucleations spread at unit speed
- ▶ They annihilate upon meeting
- ▶ \rightsquigarrow height function



Polynuclear Growth (PNG) [Hammersley '72]

- ▶ Poisson space-time points initiate nucleations
- ▶ Nucleations spread at unit speed
- ▶ They annihilate upon meeting
- ▶ \rightsquigarrow height function



Polynuclear Growth (PNG) [Hammersley '72]

- ▶ Poisson space-time points initiate nucleations
- ▶ Nucleations spread at unit speed
- ▶ They annihilate upon meeting
- ▶ \rightsquigarrow height function



Polynuclear Growth (PNG) [Hammersley '72]

- ▶ Poisson space-time points initiate nucleations
- ▶ Nucleations spread at unit speed
- ▶ They annihilate upon meeting
- ▶ \rightsquigarrow height function

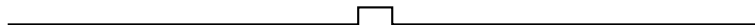

Polynuclear Growth (PNG) [Hammersley '72]

- ▶ Poisson space-time points initiate nucleations
- ▶ Nucleations spread at unit speed
- ▶ They annihilate upon meeting
- ▶ \rightsquigarrow height function

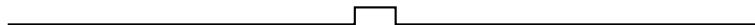

Polynuclear Growth (PNG) [Hammersley '72]

- ▶ Poisson space-time points initiate nucleations
- ▶ Nucleations spread at unit speed
- ▶ They annihilate upon meeting
- ▶ \rightsquigarrow height function

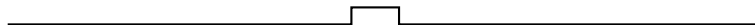

Polynuclear Growth (PNG) [Hammersley '72]

- ▶ Poisson space-time points initiate nucleations
- ▶ Nucleations spread at unit speed
- ▶ They annihilate upon meeting
- ▶ \rightsquigarrow height function

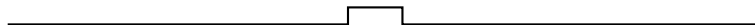

Polynuclear Growth (PNG) [Hammersley '72]

- ▶ Poisson space-time points initiate nucleations
- ▶ Nucleations spread at unit speed
- ▶ They annihilate upon meeting
- ▶ \rightsquigarrow height function

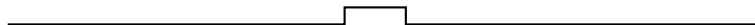

Polynuclear Growth (PNG) [Hammersley '72]

- ▶ Poisson space-time points initiate nucleations
- ▶ Nucleations spread at unit speed
- ▶ They annihilate upon meeting
- ▶ \rightsquigarrow height function

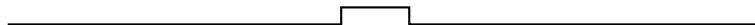

Polynuclear Growth (PNG) [Hammersley '72]

- ▶ Poisson space-time points initiate nucleations
- ▶ Nucleations spread at unit speed
- ▶ They annihilate upon meeting
- ▶ \rightsquigarrow height function



Polynuclear Growth (PNG) [Hammersley '72]

- ▶ Poisson space-time points initiate nucleations
- ▶ Nucleations spread at unit speed
- ▶ They annihilate upon meeting
- ▶ \rightsquigarrow height function



Polynuclear Growth (PNG) [Hammersley '72]

- ▶ Poisson space-time points initiate nucleations
- ▶ Nucleations spread at unit speed
- ▶ They annihilate upon meeting
- ▶ \rightsquigarrow height function

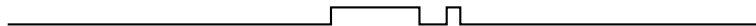

Polynuclear Growth (PNG) [Hammersley '72]

- ▶ Poisson space-time points initiate nucleations
- ▶ Nucleations spread at unit speed
- ▶ They annihilate upon meeting
- ▶ \rightsquigarrow height function

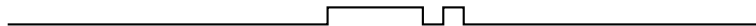

Polynuclear Growth (PNG) [Hammersley '72]

- ▶ Poisson space-time points initiate nucleations
- ▶ Nucleations spread at unit speed
- ▶ They annihilate upon meeting
- ▶ \rightsquigarrow height function

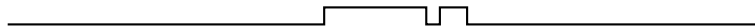

Polynuclear Growth (PNG) [Hammersley '72]

- ▶ Poisson space-time points initiate nucleations
- ▶ Nucleations spread at unit speed
- ▶ They annihilate upon meeting
- ▶ \rightsquigarrow height function

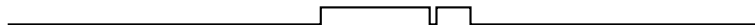

Polynuclear Growth (PNG) [Hammersley '72]

- ▶ Poisson space-time points initiate nucleations
- ▶ Nucleations spread at unit speed
- ▶ They annihilate upon meeting
- ▶ \rightsquigarrow height function

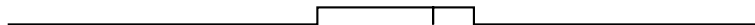

Polynuclear Growth (PNG) [Hammersley '72]

- ▶ Poisson space-time points initiate nucleations
- ▶ Nucleations spread at unit speed
- ▶ They annihilate upon meeting
- ▶ \rightsquigarrow height function

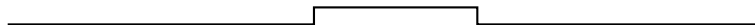

Polynuclear Growth (PNG) [Hammersley '72]

- ▶ Poisson space-time points initiate nucleations
- ▶ Nucleations spread at unit speed
- ▶ They annihilate upon meeting
- ▶ \rightsquigarrow height function

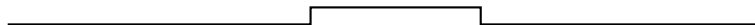

Polynuclear Growth (PNG) [Hammersley '72]

- ▶ Poisson space-time points initiate nucleations
- ▶ Nucleations spread at unit speed
- ▶ They annihilate upon meeting
- ▶ \rightsquigarrow height function

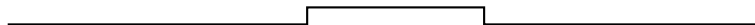

Polynuclear Growth (PNG) [Hammersley '72]

- ▶ Poisson space-time points initiate nucleations
- ▶ Nucleations spread at unit speed
- ▶ They annihilate upon meeting
- ▶ \rightsquigarrow height function

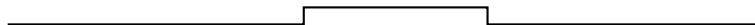

Polynuclear Growth (PNG) [Hammersley '72]

- ▶ Poisson space-time points initiate nucleations
- ▶ Nucleations spread at unit speed
- ▶ They annihilate upon meeting
- ▶ \rightsquigarrow height function

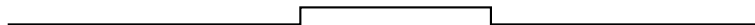

Polynuclear Growth (PNG) [Hammersley '72]

- ▶ Poisson space-time points initiate nucleations
- ▶ Nucleations spread at unit speed
- ▶ They annihilate upon meeting
- ▶ \rightsquigarrow height function

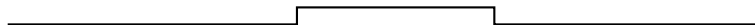

Polynuclear Growth (PNG) [Hammersley '72]

- ▶ Poisson space-time points initiate nucleations
- ▶ Nucleations spread at unit speed
- ▶ They annihilate upon meeting
- ▶ \rightsquigarrow height function

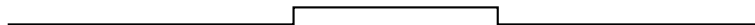

Polynuclear Growth (PNG) [Hammersley '72]

- ▶ Poisson space-time points initiate nucleations
- ▶ Nucleations spread at unit speed
- ▶ They annihilate upon meeting
- ▶ \rightsquigarrow height function

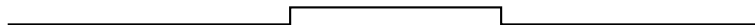

Polynuclear Growth (PNG) [Hammersley '72]

- ▶ Poisson space-time points initiate nucleations
- ▶ Nucleations spread at unit speed
- ▶ They annihilate upon meeting
- ▶ \rightsquigarrow height function

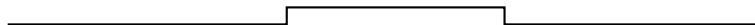

Polynuclear Growth (PNG) [Hammersley '72]

- ▶ Poisson space-time points initiate nucleations
- ▶ Nucleations spread at unit speed
- ▶ They annihilate upon meeting
- ▶ \rightsquigarrow height function

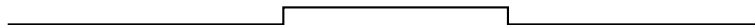

Polynuclear Growth (PNG) [Hammersley '72]

- ▶ Poisson space-time points initiate nucleations
- ▶ Nucleations spread at unit speed
- ▶ They annihilate upon meeting
- ▶ \rightsquigarrow height function

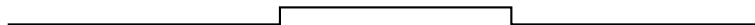

Polynuclear Growth (PNG) [Hammersley '72]

- ▶ Poisson space-time points initiate nucleations
- ▶ Nucleations spread at unit speed
- ▶ They annihilate upon meeting
- ▶ \rightsquigarrow height function

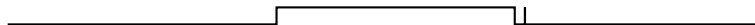

Polynuclear Growth (PNG) [Hammersley '72]

- ▶ Poisson space-time points initiate nucleations
- ▶ Nucleations spread at unit speed
- ▶ They annihilate upon meeting
- ▶ \rightsquigarrow height function

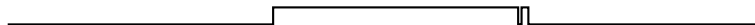

Polynuclear Growth (PNG) [Hammersley '72]

- ▶ Poisson space-time points initiate nucleations
- ▶ Nucleations spread at unit speed
- ▶ They annihilate upon meeting
- ▶ \rightsquigarrow height function

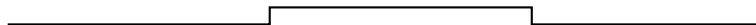

Polynuclear Growth (PNG) [Hammersley '72]

- ▶ Poisson space-time points initiate nucleations
- ▶ Nucleations spread at unit speed
- ▶ They annihilate upon meeting
- ▶ \rightsquigarrow height function

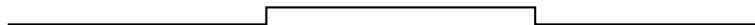

Polynuclear Growth (PNG) [Hammersley '72]

- ▶ Poisson space-time points initiate nucleations
- ▶ Nucleations spread at unit speed
- ▶ They annihilate upon meeting
- ▶ \rightsquigarrow height function

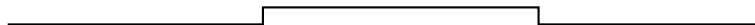

Polynuclear Growth (PNG) [Hammersley '72]

- ▶ Poisson space-time points initiate nucleations
- ▶ Nucleations spread at unit speed
- ▶ They annihilate upon meeting
- ▶ \rightsquigarrow height function

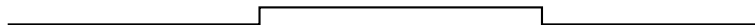

Polynuclear Growth (PNG) [Hammersley '72]

- ▶ Poisson space-time points initiate nucleations
- ▶ Nucleations spread at unit speed
- ▶ They annihilate upon meeting
- ▶ \rightsquigarrow height function

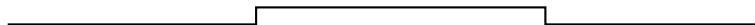

Polynuclear Growth (PNG) [Hammersley '72]

- ▶ Poisson space-time points initiate nucleations
- ▶ Nucleations spread at unit speed
- ▶ They annihilate upon meeting
- ▶ \rightsquigarrow height function

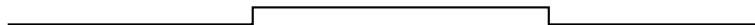

Polynuclear Growth (PNG) [Hammersley '72]

- ▶ Poisson space-time points initiate nucleations
- ▶ Nucleations spread at unit speed
- ▶ They annihilate upon meeting
- ▶ \rightsquigarrow height function

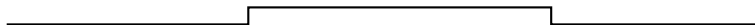

Polynuclear Growth (PNG) [Hammersley '72]

- ▶ Poisson space-time points initiate nucleations
- ▶ Nucleations spread at unit speed
- ▶ They annihilate upon meeting
- ▶ \rightsquigarrow height function

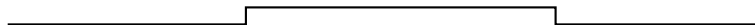

Polynuclear Growth (PNG) [Hammersley '72]

- ▶ Poisson space-time points initiate nucleations
- ▶ Nucleations spread at unit speed
- ▶ They annihilate upon meeting
- ▶ \rightsquigarrow height function

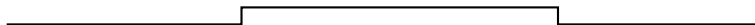

Polynuclear Growth (PNG) [Hammersley '72]

- ▶ Poisson space-time points initiate nucleations
- ▶ Nucleations spread at unit speed
- ▶ They annihilate upon meeting
- ▶ \rightsquigarrow height function

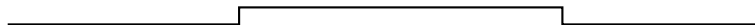

Polynuclear Growth (PNG) [Hammersley '72]

- ▶ Poisson space-time points initiate nucleations
- ▶ Nucleations spread at unit speed
- ▶ They annihilate upon meeting
- ▶ \rightsquigarrow height function

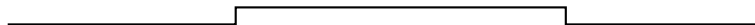

Polynuclear Growth (PNG) [Hammersley '72]

- ▶ Poisson space-time points initiate nucleations
- ▶ Nucleations spread at unit speed
- ▶ They annihilate upon meeting
- ▶ \rightsquigarrow height function

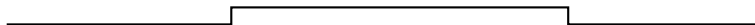

Polynuclear Growth (PNG) [Hammersley '72]

- ▶ Poisson space-time points initiate nucleations
- ▶ Nucleations spread at unit speed
- ▶ They annihilate upon meeting
- ▶ \rightsquigarrow height function

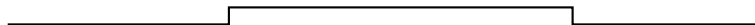

Polynuclear Growth (PNG) [Hammersley '72]

- ▶ Poisson space-time points initiate nucleations
- ▶ Nucleations spread at unit speed
- ▶ They annihilate upon meeting
- ▶ \rightsquigarrow height function

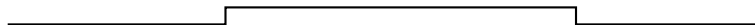

Polynuclear Growth (PNG) [Hammersley '72]

- ▶ Poisson space-time points initiate nucleations
- ▶ Nucleations spread at unit speed
- ▶ They annihilate upon meeting
- ▶ \rightsquigarrow height function

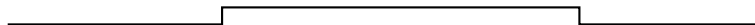

Polynuclear Growth (PNG) [Hammersley '72]

- ▶ Poisson space-time points initiate nucleations
- ▶ Nucleations spread at unit speed
- ▶ They annihilate upon meeting
- ▶ \rightsquigarrow height function

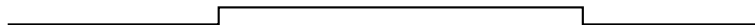

Polynuclear Growth (PNG) [Hammersley '72]

- ▶ Poisson space-time points initiate nucleations
- ▶ Nucleations spread at unit speed
- ▶ They annihilate upon meeting
- ▶ \rightsquigarrow height function

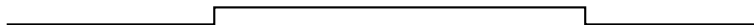

Polynuclear Growth (PNG) [Hammersley '72]

- ▶ Poisson space-time points initiate nucleations
- ▶ Nucleations spread at unit speed
- ▶ They annihilate upon meeting
- ▶ \rightsquigarrow height function

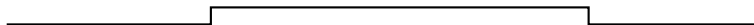

Polynuclear Growth (PNG) [Hammersley '72]

- ▶ Poisson space-time points initiate nucleations
- ▶ Nucleations spread at unit speed
- ▶ They annihilate upon meeting
- ▶ \rightsquigarrow height function

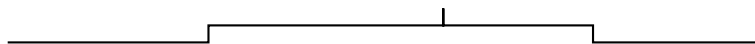

Polynuclear Growth (PNG) [Hammersley '72]

- ▶ Poisson space-time points initiate nucleations
- ▶ Nucleations spread at unit speed
- ▶ They annihilate upon meeting
- ▶ \rightsquigarrow height function

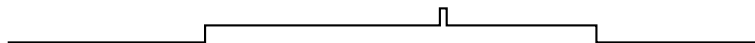

Polynuclear Growth (PNG) [Hammersley '72]

- ▶ Poisson space-time points initiate nucleations
- ▶ Nucleations spread at unit speed
- ▶ They annihilate upon meeting
- ▶ \rightsquigarrow height function

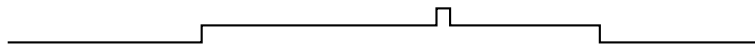

Polynuclear Growth (PNG) [Hammersley '72]

- ▶ Poisson space-time points initiate nucleations
- ▶ Nucleations spread at unit speed
- ▶ They annihilate upon meeting
- ▶ \rightsquigarrow height function

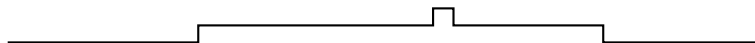

Polynuclear Growth (PNG) [Hammersley '72]

- ▶ Poisson space-time points initiate nucleations
- ▶ Nucleations spread at unit speed
- ▶ They annihilate upon meeting
- ▶ \rightsquigarrow height function

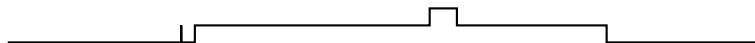

Polynuclear Growth (PNG) [Hammersley '72]

- ▶ Poisson space-time points initiate nucleations
- ▶ Nucleations spread at unit speed
- ▶ They annihilate upon meeting
- ▶ \rightsquigarrow height function

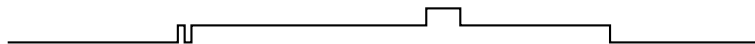

Polynuclear Growth (PNG) [Hammersley '72]

- ▶ Poisson space-time points initiate nucleations
- ▶ Nucleations spread at unit speed
- ▶ They annihilate upon meeting
- ▶ \rightsquigarrow height function

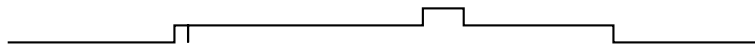

Polynuclear Growth (PNG) [Hammersley '72]

- ▶ Poisson space-time points initiate nucleations
- ▶ Nucleations spread at unit speed
- ▶ They annihilate upon meeting
- ▶ \rightsquigarrow height function

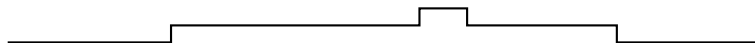

Polynuclear Growth (PNG) [Hammersley '72]

- ▶ Poisson space-time points initiate nucleations
- ▶ Nucleations spread at unit speed
- ▶ They annihilate upon meeting
- ▶ \rightsquigarrow height function

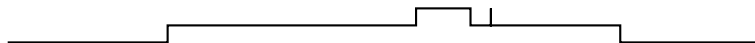

Polynuclear Growth (PNG) [Hammersley '72]

- ▶ Poisson space-time points initiate nucleations
- ▶ Nucleations spread at unit speed
- ▶ They annihilate upon meeting
- ▶ \rightsquigarrow height function

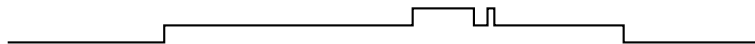

Polynuclear Growth (PNG) [Hammersley '72]

- ▶ Poisson space-time points initiate nucleations
- ▶ Nucleations spread at unit speed
- ▶ They annihilate upon meeting
- ▶ \rightsquigarrow height function

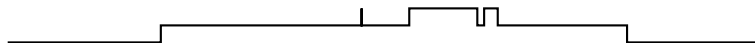

Polynuclear Growth (PNG) [Hammersley '72]

- ▶ Poisson space-time points initiate nucleations
- ▶ Nucleations spread at unit speed
- ▶ They annihilate upon meeting
- ▶ \rightsquigarrow height function

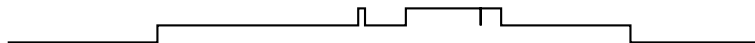

Polynuclear Growth (PNG) [Hammersley '72]

- ▶ Poisson space-time points initiate nucleations
- ▶ Nucleations spread at unit speed
- ▶ They annihilate upon meeting
- ▶ \rightsquigarrow height function

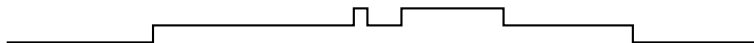

Polynuclear Growth (PNG) [Hammersley '72]

- ▶ Poisson space-time points initiate nucleations
- ▶ Nucleations spread at unit speed
- ▶ They annihilate upon meeting
- ▶ \rightsquigarrow height function



Polynuclear Growth (PNG) [Hammersley '72]

- ▶ Poisson space-time points initiate nucleations
- ▶ Nucleations spread at unit speed
- ▶ They annihilate upon meeting
- ▶ \rightsquigarrow height function



Polynuclear Growth (PNG) [Hammersley '72]

- ▶ Poisson space-time points initiate nucleations
- ▶ Nucleations spread at unit speed
- ▶ They annihilate upon meeting
- ▶ \rightsquigarrow height function

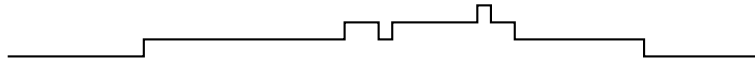

Polynuclear Growth (PNG) [Hammersley '72]

- ▶ Poisson space-time points initiate nucleations
- ▶ Nucleations spread at unit speed
- ▶ They annihilate upon meeting
- ▶ \rightsquigarrow height function

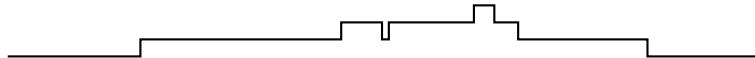

Polynuclear Growth (PNG) [Hammersley '72]

- ▶ Poisson space-time points initiate nucleations
- ▶ Nucleations spread at unit speed
- ▶ They annihilate upon meeting
- ▶ \rightsquigarrow height function

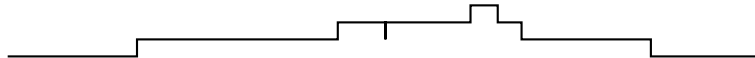

Polynuclear Growth (PNG) [Hammersley '72]

- ▶ Poisson space-time points initiate nucleations
- ▶ Nucleations spread at unit speed
- ▶ They annihilate upon meeting
- ▶ \rightsquigarrow height function

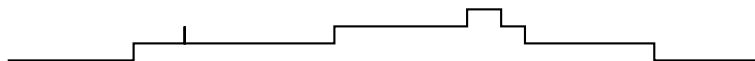

Polynuclear Growth (PNG) [Hammersley '72]

- ▶ Poisson space-time points initiate nucleations
- ▶ Nucleations spread at unit speed
- ▶ They annihilate upon meeting
- ▶ \rightsquigarrow height function

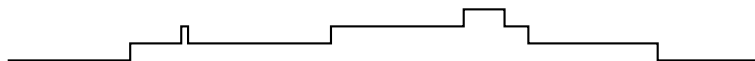

Polynuclear Growth (PNG) [Hammersley '72]

- ▶ Poisson space-time points initiate nucleations
- ▶ Nucleations spread at unit speed
- ▶ They annihilate upon meeting
- ▶ \rightsquigarrow height function

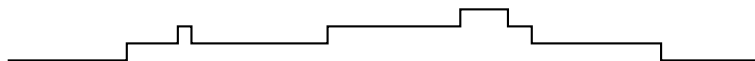

Polynuclear Growth (PNG) [Hammersley '72]

- ▶ Poisson space-time points initiate nucleations
- ▶ Nucleations spread at unit speed
- ▶ They annihilate upon meeting
- ▶ \rightsquigarrow height function

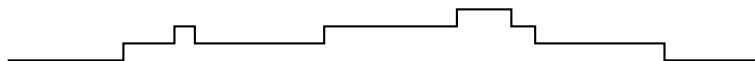

Polynuclear Growth (PNG) [Hammersley '72]

- ▶ Poisson space-time points initiate nucleations
- ▶ Nucleations spread at unit speed
- ▶ They annihilate upon meeting
- ▶ \rightsquigarrow height function

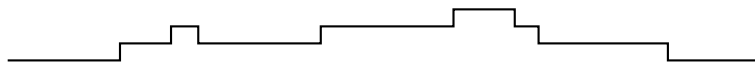

Polynuclear Growth (PNG) [Hammersley '72]

- ▶ Poisson space-time points initiate nucleations
- ▶ Nucleations spread at unit speed
- ▶ They annihilate upon meeting
- ▶ \rightsquigarrow height function

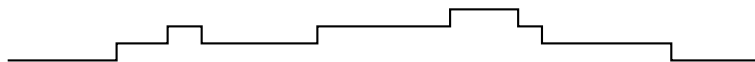

Polynuclear Growth (PNG) [Hammersley '72]

- ▶ Poisson space-time points initiate nucleations
- ▶ Nucleations spread at unit speed
- ▶ They annihilate upon meeting
- ▶ \rightsquigarrow height function

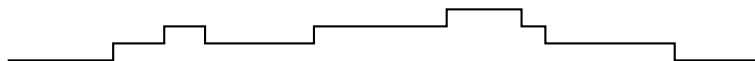

Polynuclear Growth (PNG) [Hammersley '72]

- ▶ Poisson space-time points initiate nucleations
- ▶ Nucleations spread at unit speed
- ▶ They annihilate upon meeting
- ▶ \rightsquigarrow height function

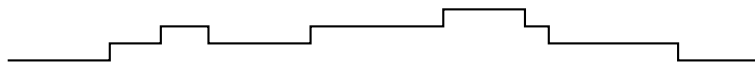

Polynuclear Growth (PNG) [Hammersley '72]

- ▶ Poisson space-time points initiate nucleations
- ▶ Nucleations spread at unit speed
- ▶ They annihilate upon meeting
- ▶ \rightsquigarrow height function

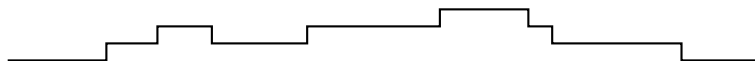

Polynuclear Growth (PNG) [Hammersley '72]

- ▶ Poisson space-time points initiate nucleations
- ▶ Nucleations spread at unit speed
- ▶ They annihilate upon meeting
- ▶ \rightsquigarrow height function

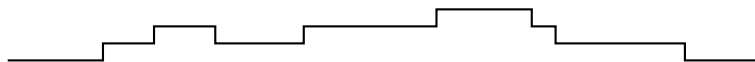

Polynuclear Growth (PNG) [Hammersley '72]

- ▶ Poisson space-time points initiate nucleations
- ▶ Nucleations spread at unit speed
- ▶ They annihilate upon meeting
- ▶ \rightsquigarrow height function

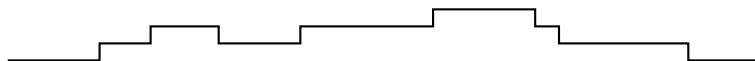

Polynuclear Growth (PNG) [Hammersley '72]

- ▶ Poisson space-time points initiate nucleations
- ▶ Nucleations spread at unit speed
- ▶ They annihilate upon meeting
- ▶ \rightsquigarrow height function

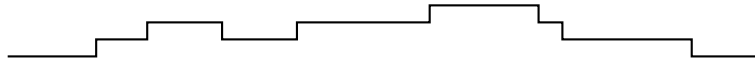

Polynuclear Growth (PNG) [Hammersley '72]

- ▶ Poisson space-time points initiate nucleations
- ▶ Nucleations spread at unit speed
- ▶ They annihilate upon meeting
- ▶ \rightsquigarrow height function

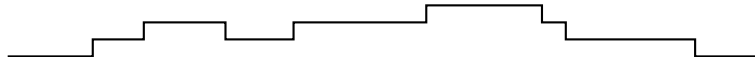

Polynuclear Growth (PNG) [Hammersley '72]

- ▶ Poisson space-time points initiate nucleations
- ▶ Nucleations spread at unit speed
- ▶ They annihilate upon meeting
- ▶ \rightsquigarrow height function

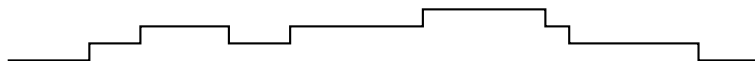

Polynuclear Growth (PNG) [Hammersley '72]

- ▶ Poisson space-time points initiate nucleations
- ▶ Nucleations spread at unit speed
- ▶ They annihilate upon meeting
- ▶ \rightsquigarrow height function

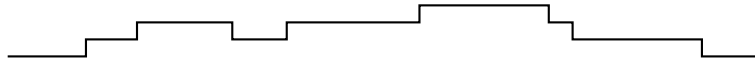

Polynuclear Growth (PNG) [Hammersley '72]

- ▶ Poisson space-time points initiate nucleations
- ▶ Nucleations spread at unit speed
- ▶ They annihilate upon meeting
- ▶ \rightsquigarrow height function

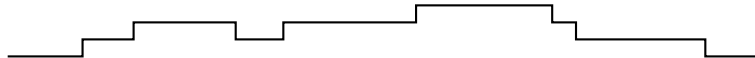

Polynuclear Growth (PNG) [Hammersley '72]

- ▶ Poisson space-time points initiate nucleations
- ▶ Nucleations spread at unit speed
- ▶ They annihilate upon meeting
- ▶ \rightsquigarrow height function

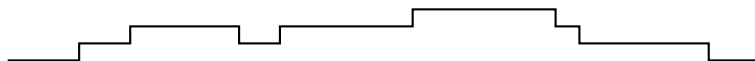

Polynuclear Growth (PNG) [Hammersley '72]

- ▶ Poisson space-time points initiate nucleations
- ▶ Nucleations spread at unit speed
- ▶ They annihilate upon meeting
- ▶ \rightsquigarrow height function

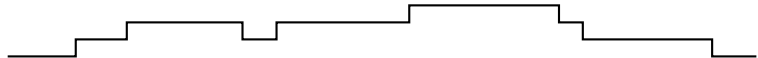

Polynuclear Growth (PNG) [Hammersley '72]

- ▶ Poisson space-time points initiate nucleations
- ▶ Nucleations spread at unit speed
- ▶ They annihilate upon meeting
- ▶ \rightsquigarrow height function

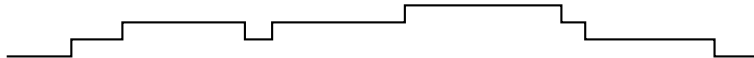

Polynuclear Growth (PNG) [Hammersley '72]

- ▶ Poisson space-time points initiate nucleations
- ▶ Nucleations spread at unit speed
- ▶ They annihilate upon meeting
- ▶ \rightsquigarrow height function

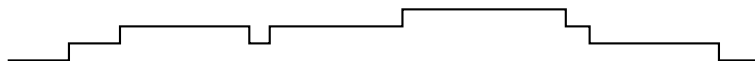

Polynuclear Growth (PNG) [Hammersley '72]

- ▶ Poisson space-time points initiate nucleations
- ▶ Nucleations spread at unit speed
- ▶ They annihilate upon meeting
- ▶ \rightsquigarrow height function

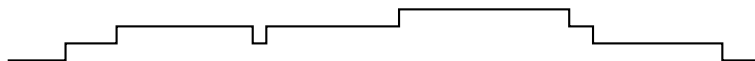

Polynuclear Growth (PNG) [Hammersley '72]

- ▶ Poisson space-time points initiate nucleations
- ▶ Nucleations spread at unit speed
- ▶ They annihilate upon meeting
- ▶ \rightsquigarrow height function

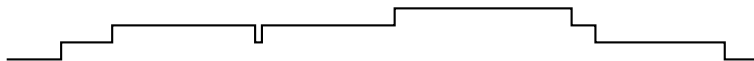

Polynuclear Growth (PNG) [Hammersley '72]

- ▶ Poisson space-time points initiate nucleations
- ▶ Nucleations spread at unit speed
- ▶ They annihilate upon meeting
- ▶ \rightsquigarrow height function

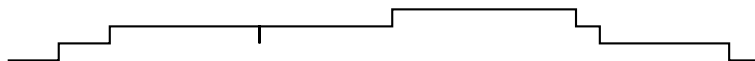

Polynuclear Growth (PNG) [Hammersley '72]

- ▶ Poisson space-time points initiate nucleations
- ▶ Nucleations spread at unit speed
- ▶ They annihilate upon meeting
- ▶ \rightsquigarrow height function

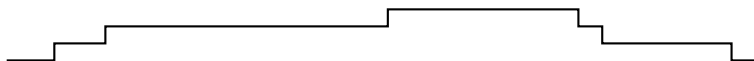

Polynuclear Growth (PNG) [Hammersley '72]

- ▶ Poisson space-time points initiate nucleations
- ▶ Nucleations spread at unit speed
- ▶ They annihilate upon meeting
- ▶ \rightsquigarrow height function

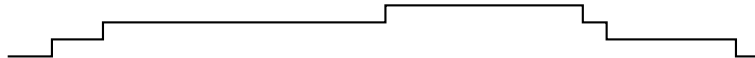

Polynuclear Growth (PNG) [Hammersley '72]

- ▶ Poisson space-time points initiate nucleations
- ▶ Nucleations spread at unit speed
- ▶ They annihilate upon meeting
- ▶ \rightsquigarrow height function

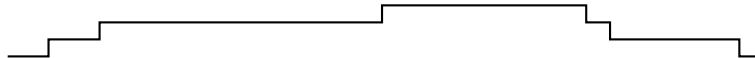

Polynuclear Growth (PNG) [Hammersley '72]

- ▶ Poisson space-time points initiate nucleations
- ▶ Nucleations spread at unit speed
- ▶ They annihilate upon meeting
- ▶ \rightsquigarrow height function

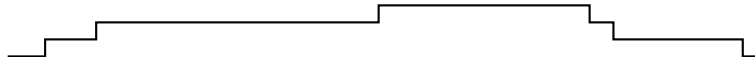

Polynuclear Growth (PNG) [Hammersley '72]

- ▶ Poisson space-time points initiate nucleations
- ▶ Nucleations spread at unit speed
- ▶ They annihilate upon meeting
- ▶ \rightsquigarrow height function

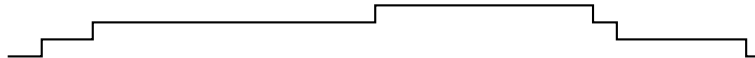

- ▶ Member of the KPZ Universality class ($\frac{1}{3}$ -power scalings, GO/UE limit distributions) [Krug-Spohn '92]

Polynuclear Growth (PNG) [Hammersley '72]

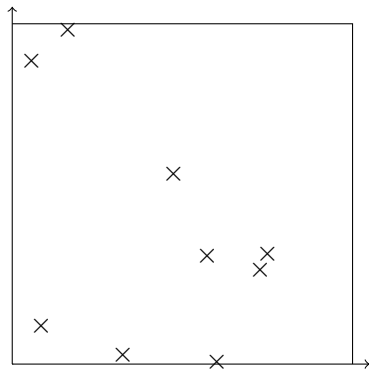

Polynuclear Growth (PNG) [Hammersley '72]

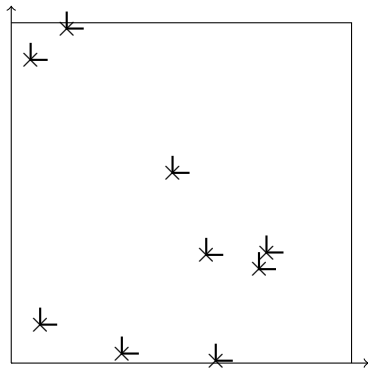

Polynuclear Growth (PNG) [Hammersley '72]

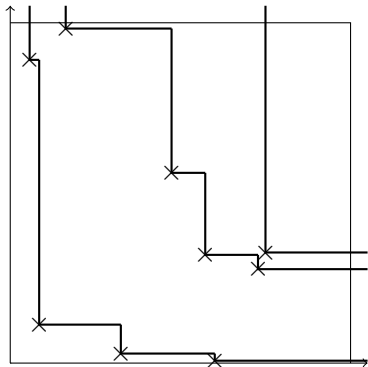

Polynuclear Growth (PNG) [Hammersley '72]

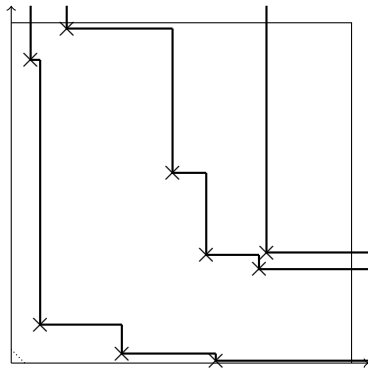

Polynuclear Growth (PNG) [Hammersley '72]

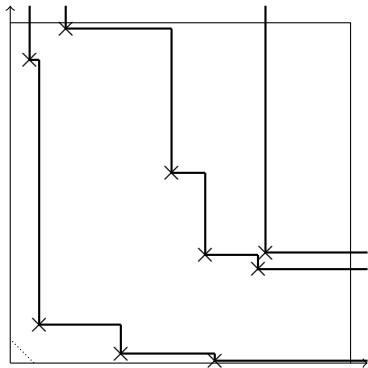

Polynuclear Growth (PNG) [Hammersley '72]

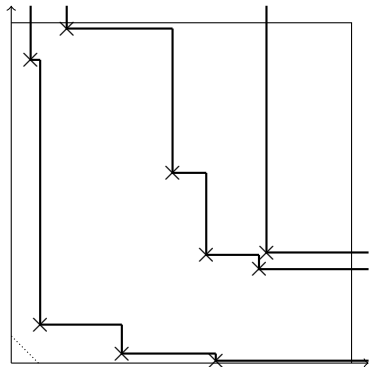

Polynuclear Growth (PNG) [Hammersley '72]

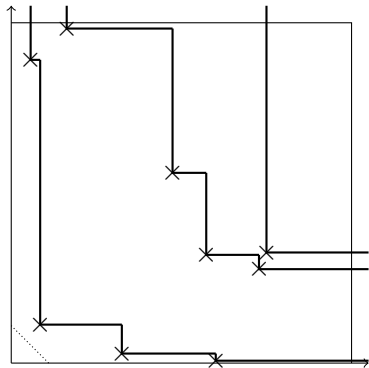

Polynuclear Growth (PNG) [Hammersley '72]

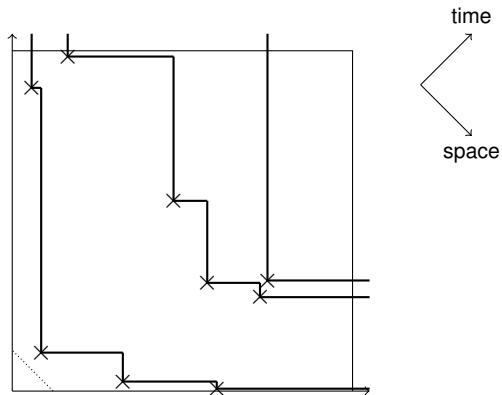

Polynuclear Growth (PNG) [Hammersley '72]

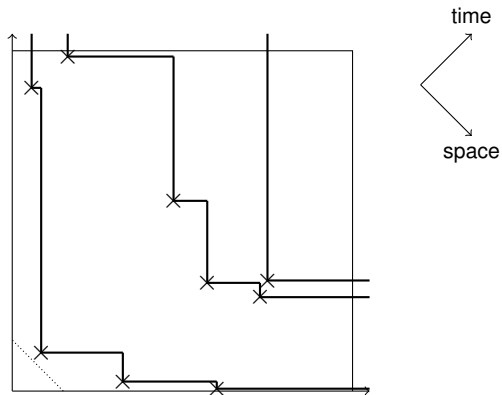

Polynuclear Growth (PNG) [Hammersley '72]

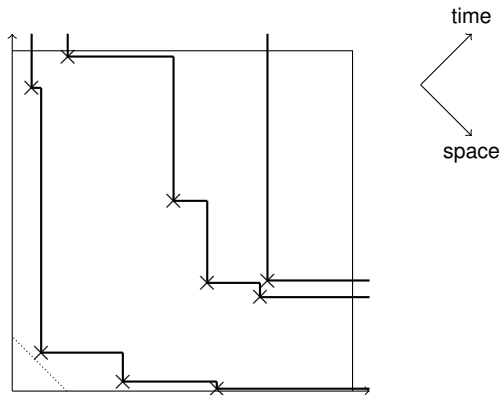

Polynuclear Growth (PNG) [Hammersley '72]

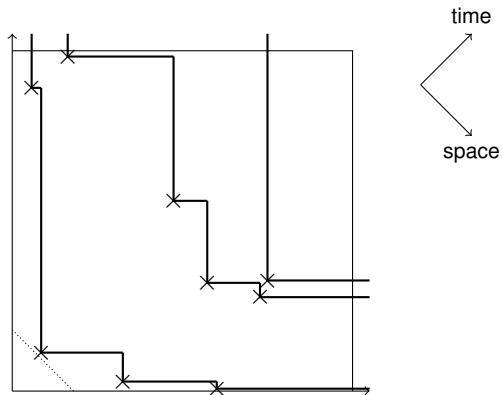

Polynuclear Growth (PNG) [Hammersley '72]

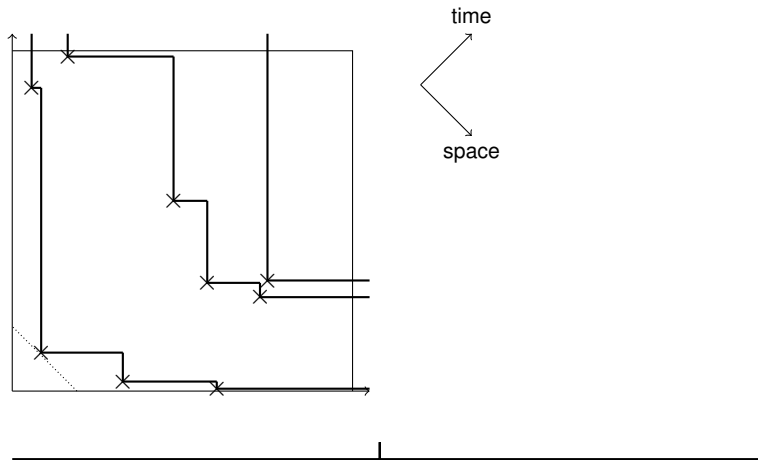

Polynuclear Growth (PNG) [Hammersley '72]

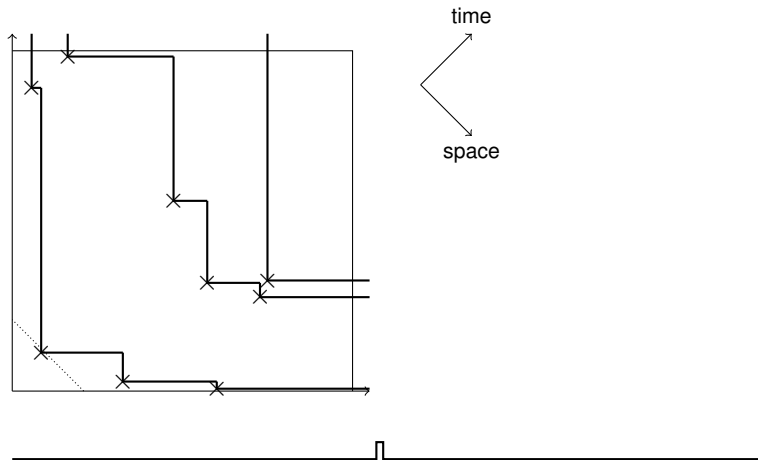

Polynuclear Growth (PNG) [Hammersley '72]

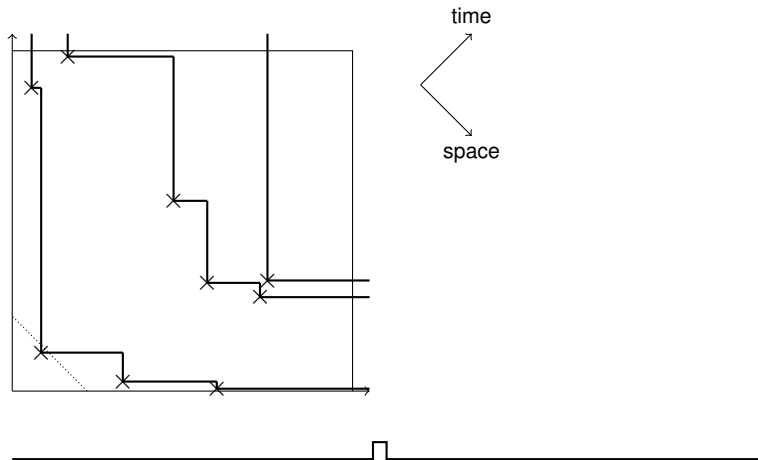

Polynuclear Growth (PNG) [Hammersley '72]

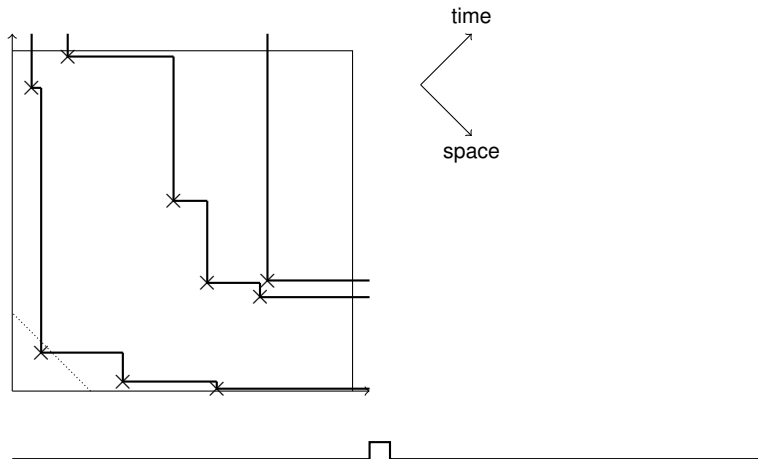

Polynuclear Growth (PNG) [Hammersley '72]

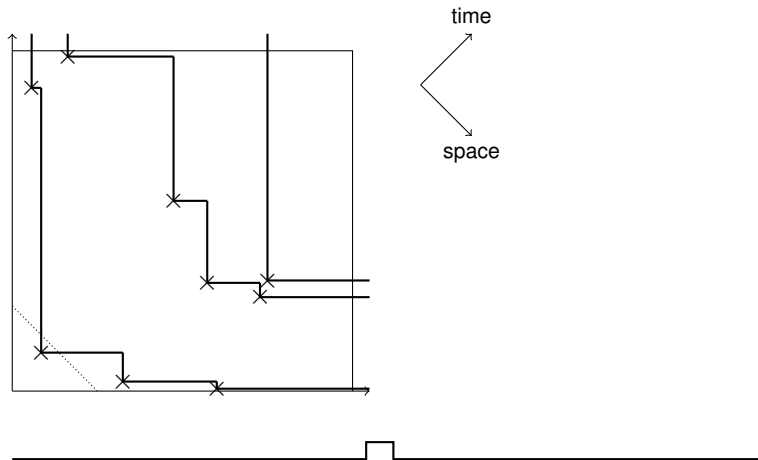

Polynuclear Growth (PNG) [Hammersley '72]

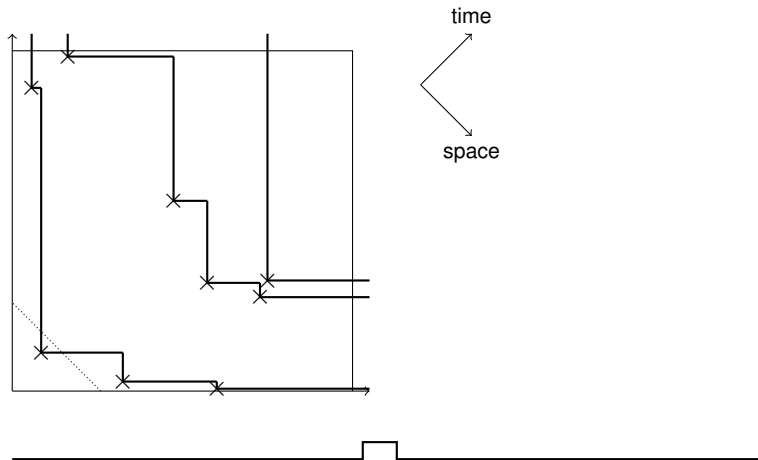

Polynuclear Growth (PNG) [Hammersley '72]

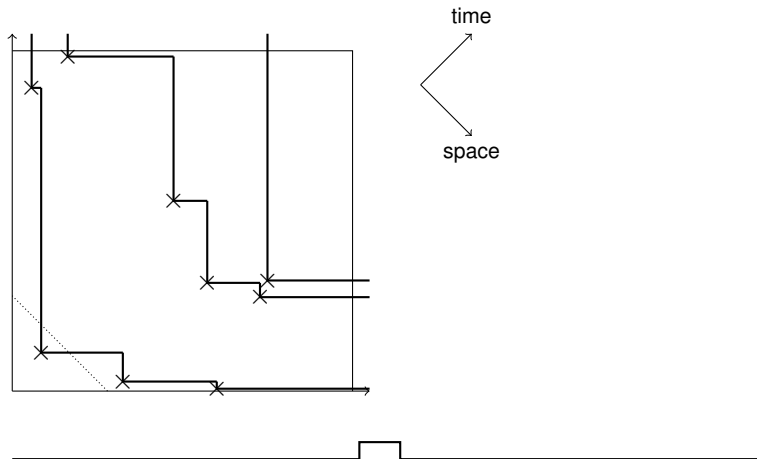

Polynuclear Growth (PNG) [Hammersley '72]

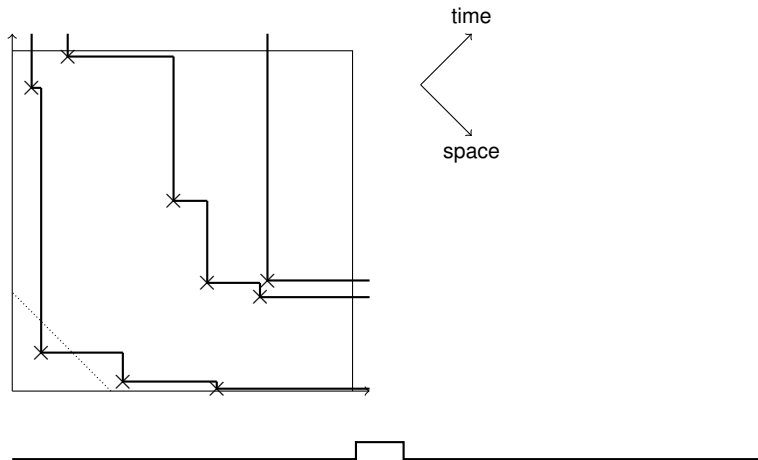

Polynuclear Growth (PNG) [Hammersley '72]

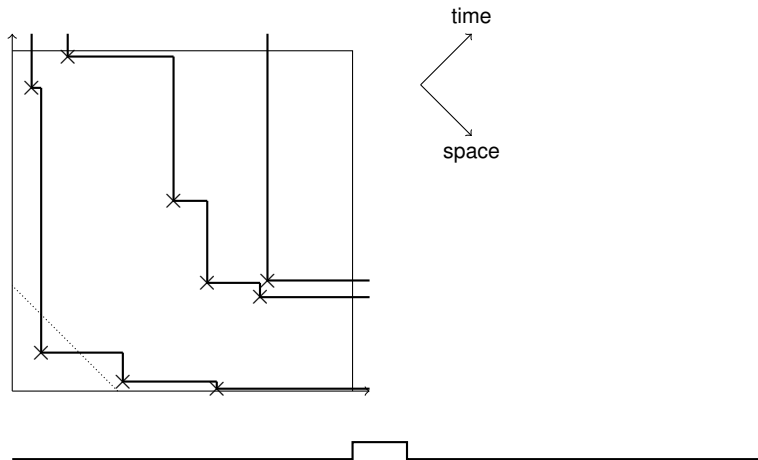

Polynuclear Growth (PNG) [Hammersley '72]

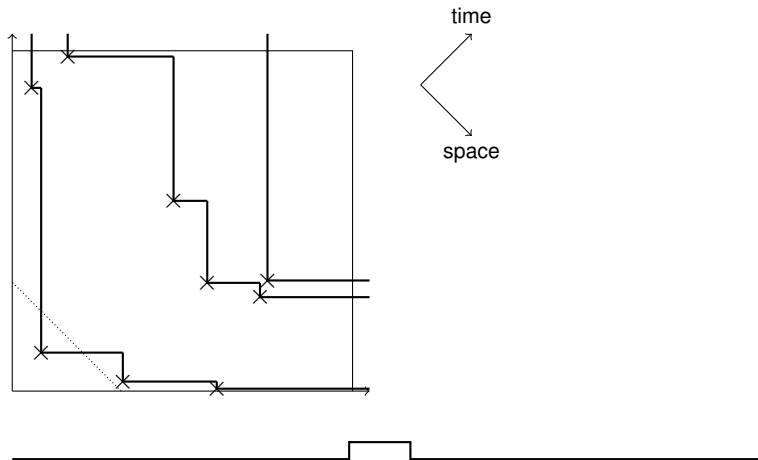

Polynuclear Growth (PNG) [Hammersley '72]

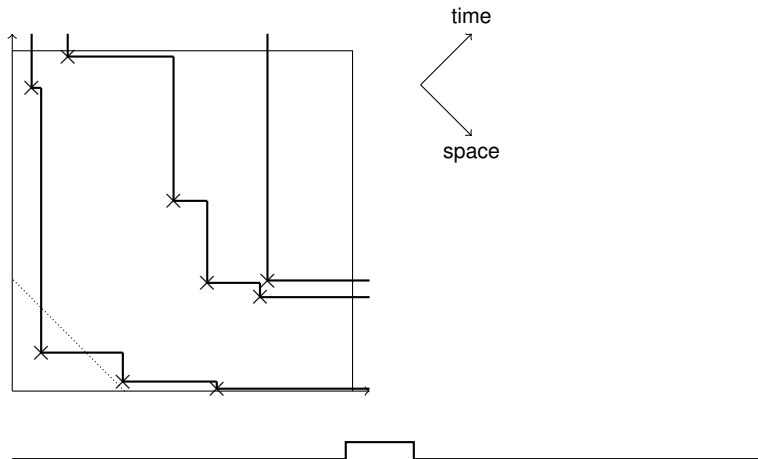

Polynuclear Growth (PNG) [Hammersley '72]

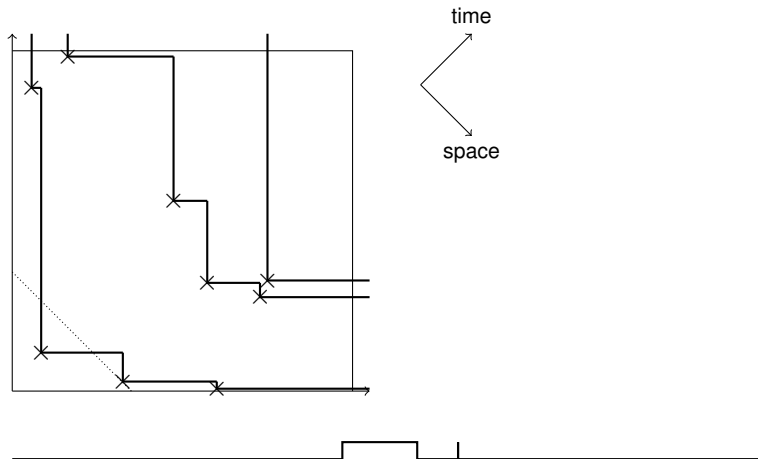

Polynuclear Growth (PNG) [Hammersley '72]

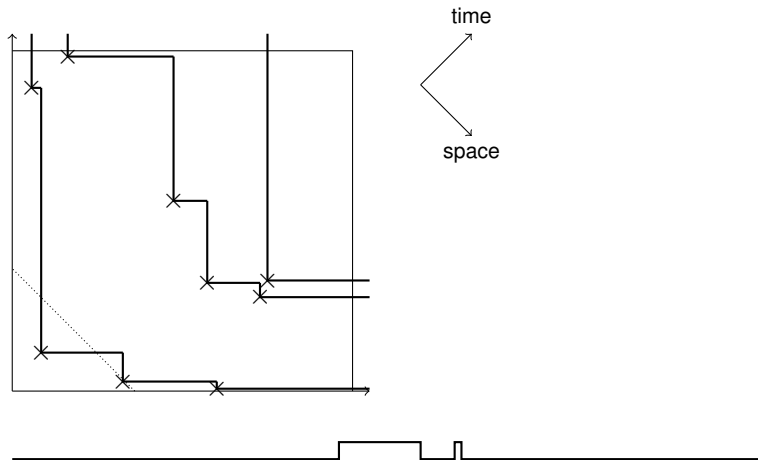

Polynuclear Growth (PNG) [Hammersley '72]

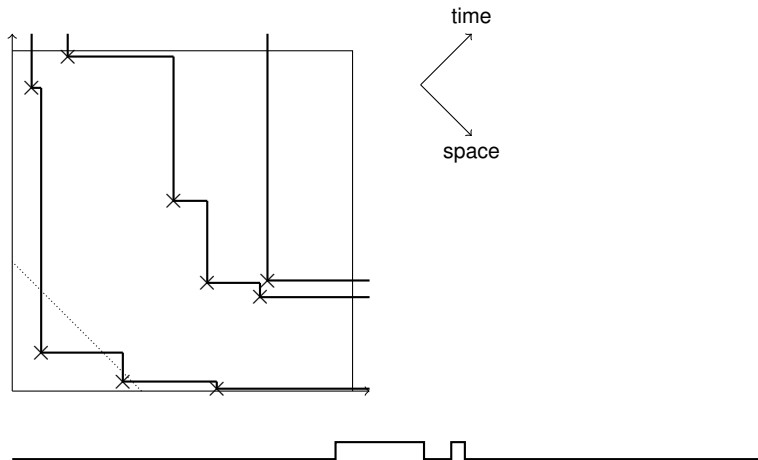

Polynuclear Growth (PNG) [Hammersley '72]

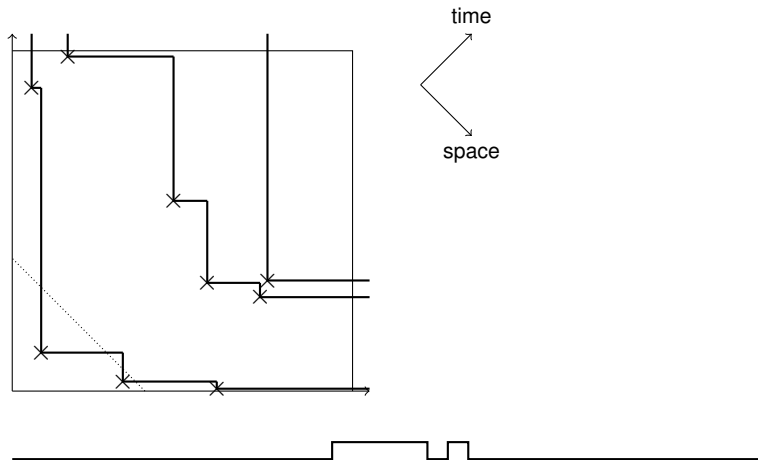

Polynuclear Growth (PNG) [Hammersley '72]

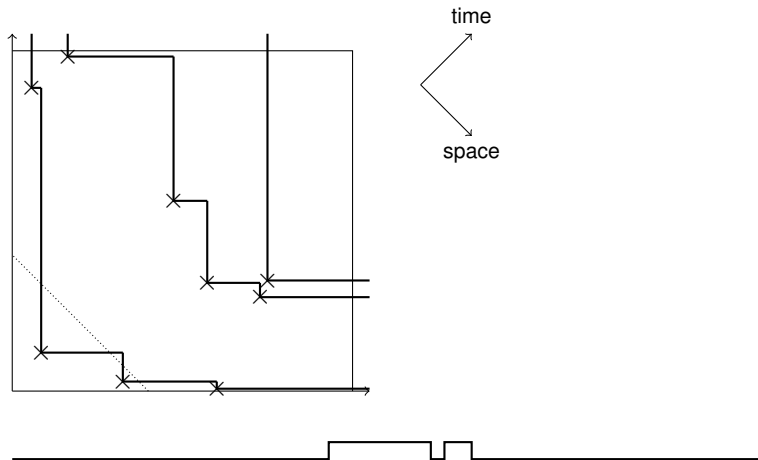

Polynuclear Growth (PNG) [Hammersley '72]

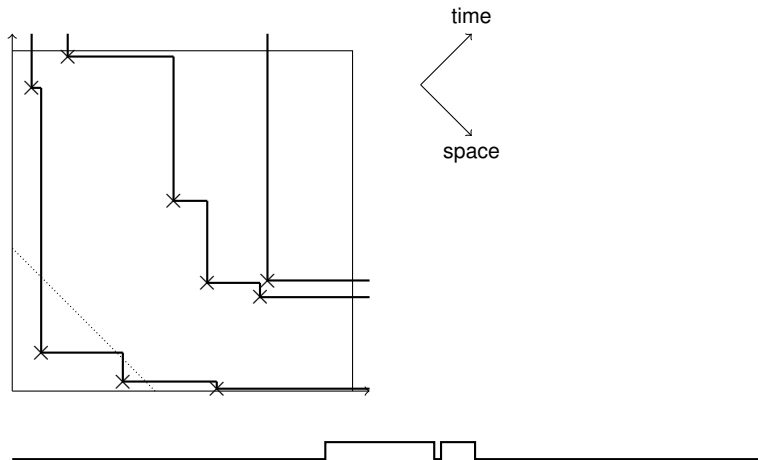

Polynuclear Growth (PNG) [Hammersley '72]

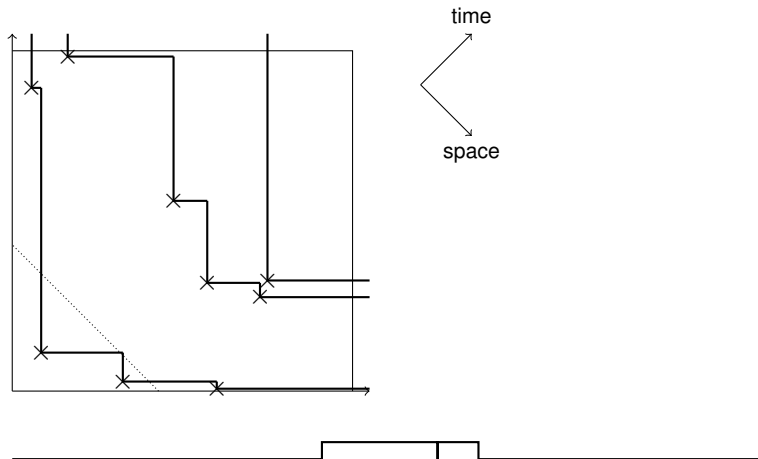

Polynuclear Growth (PNG) [Hammersley '72]

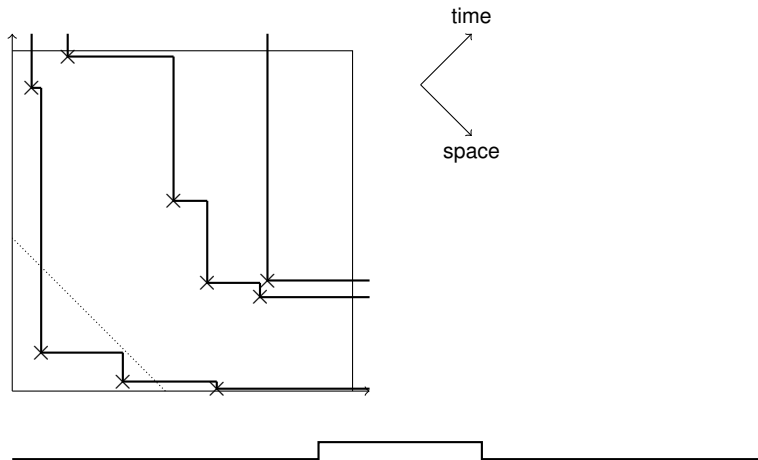

Polynuclear Growth (PNG) [Hammersley '72]

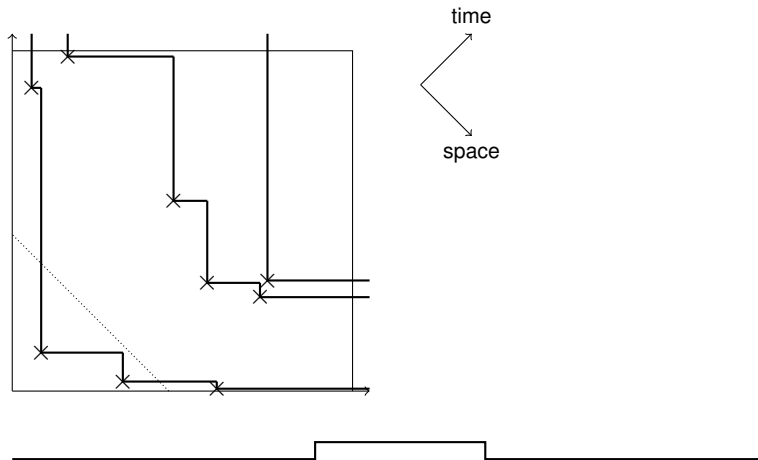

Polynuclear Growth (PNG) [Hammersley '72]

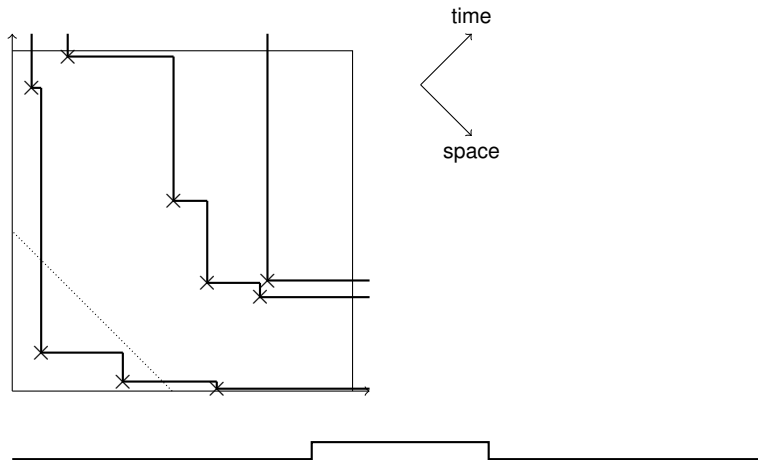

Polynuclear Growth (PNG) [Hammersley '72]

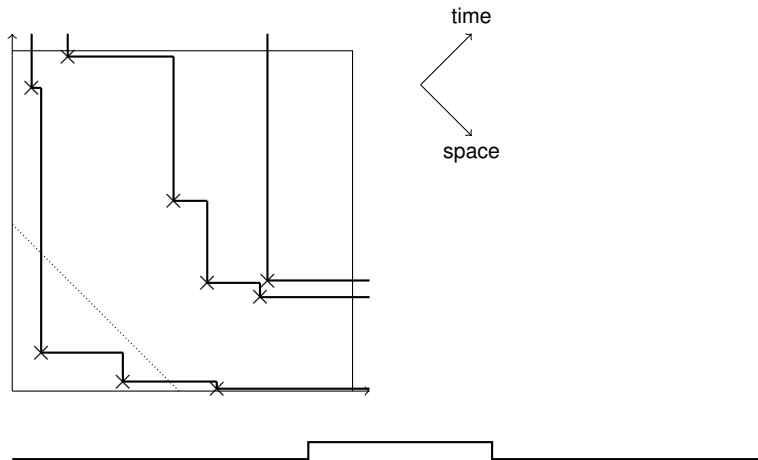

Polynuclear Growth (PNG) [Hammersley '72]

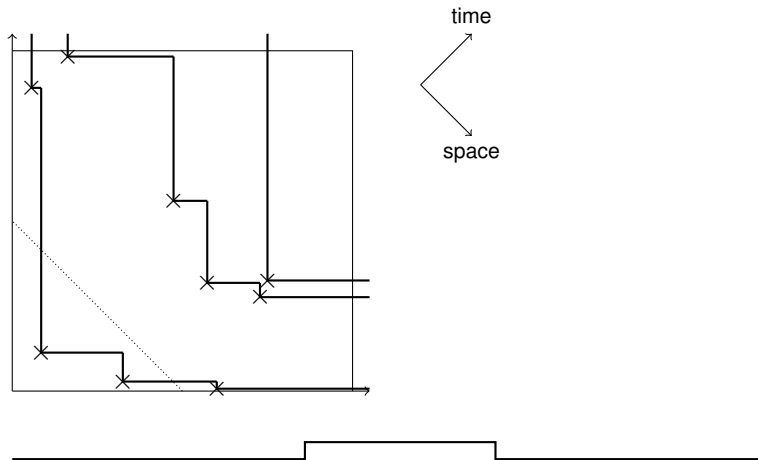

Polynuclear Growth (PNG) [Hammersley '72]

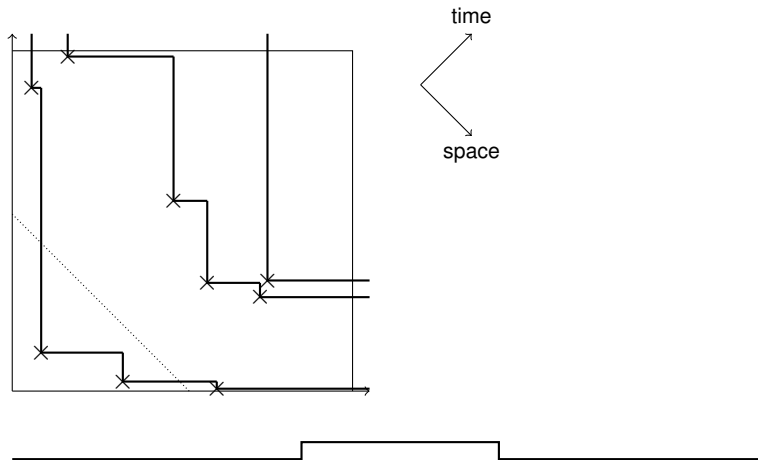

Polynuclear Growth (PNG) [Hammersley '72]

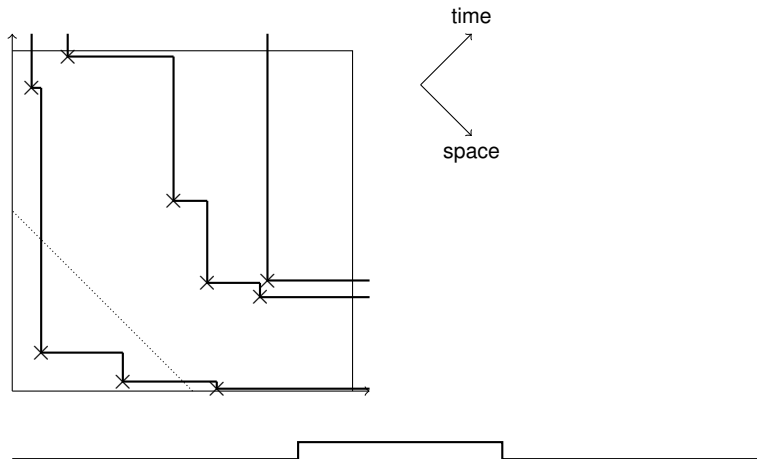

Polynuclear Growth (PNG) [Hammersley '72]

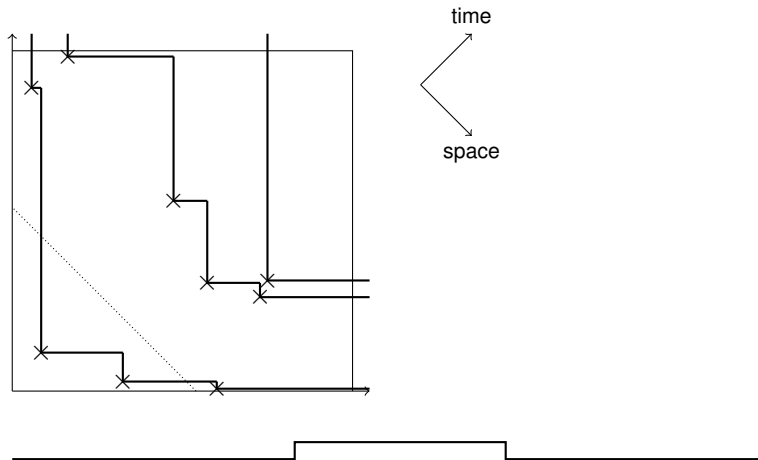

Polynuclear Growth (PNG) [Hammersley '72]

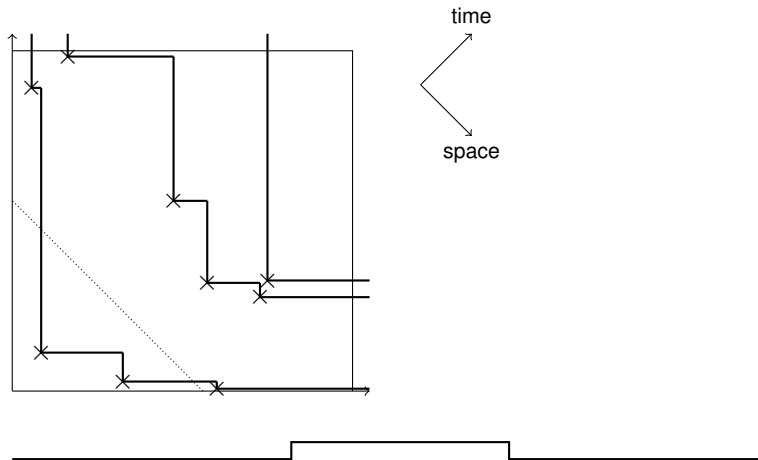

Polynuclear Growth (PNG) [Hammersley '72]

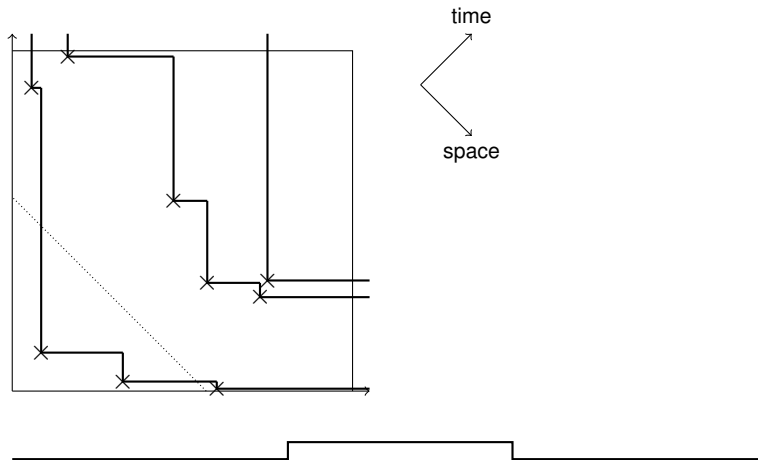

Polynuclear Growth (PNG) [Hammersley '72]

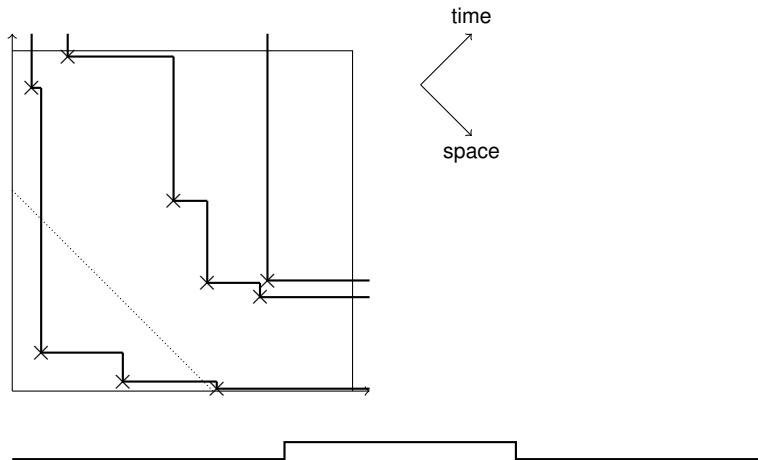

Polynuclear Growth (PNG) [Hammersley '72]

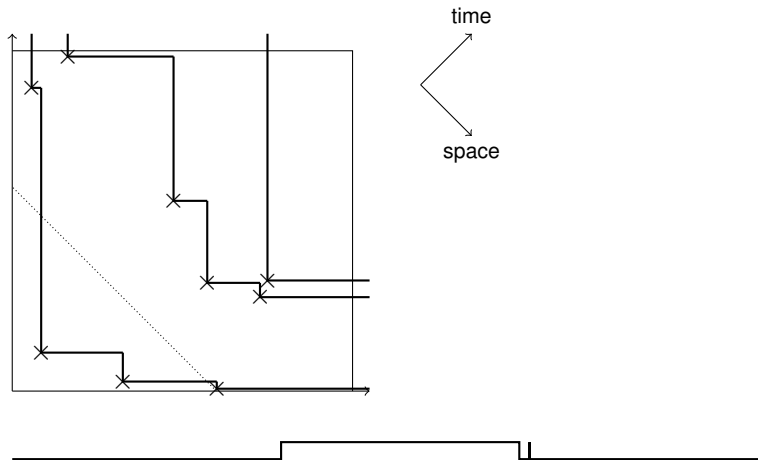

Polynuclear Growth (PNG) [Hammersley '72]

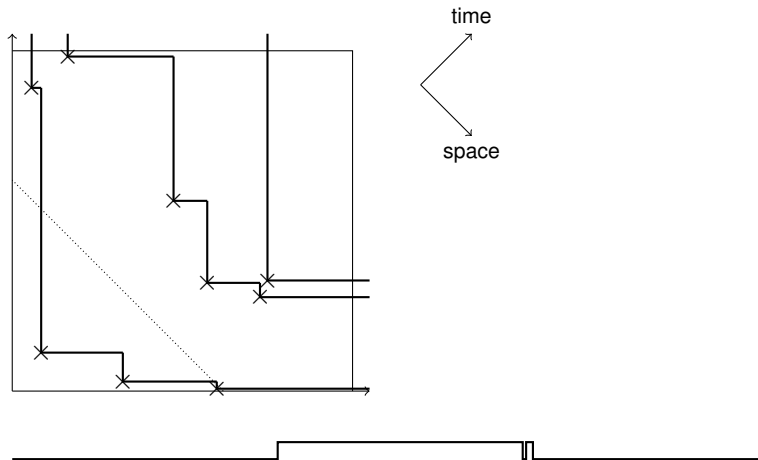

Polynuclear Growth (PNG) [Hammersley '72]

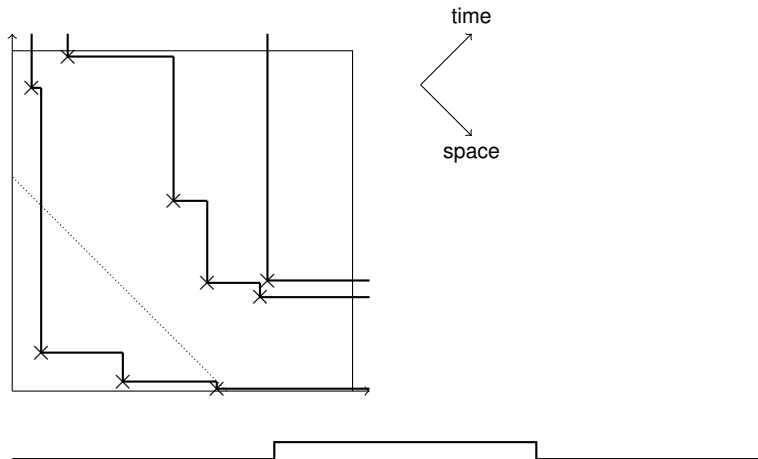

Polynuclear Growth (PNG) [Hammersley '72]

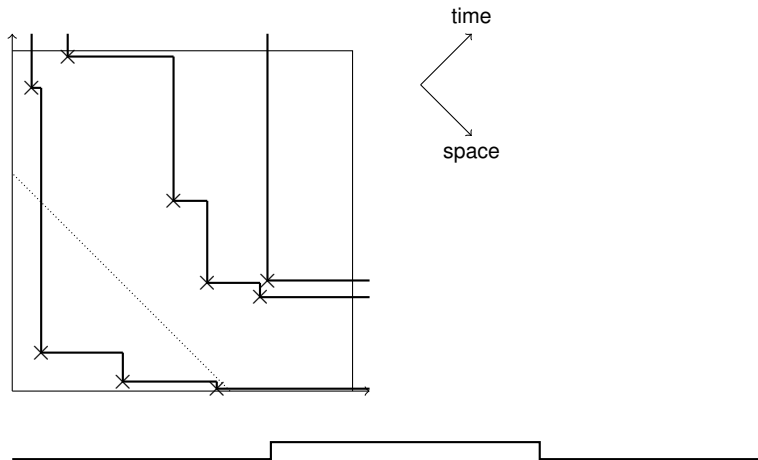

Polynuclear Growth (PNG) [Hammersley '72]

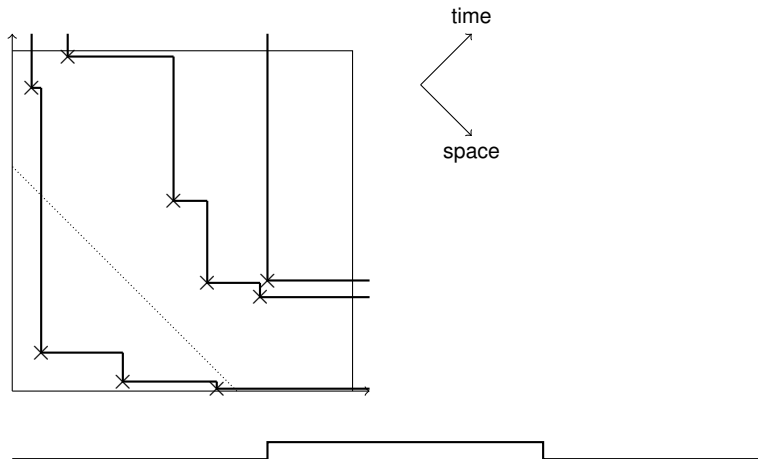

Polynuclear Growth (PNG) [Hammersley '72]

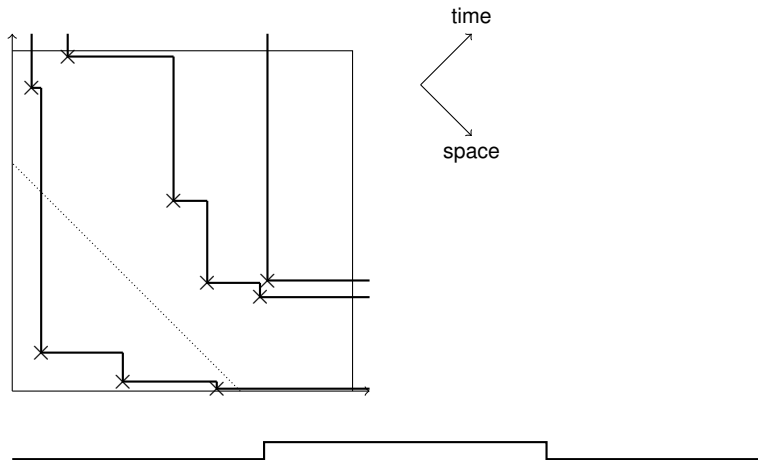

Polynuclear Growth (PNG) [Hammersley '72]

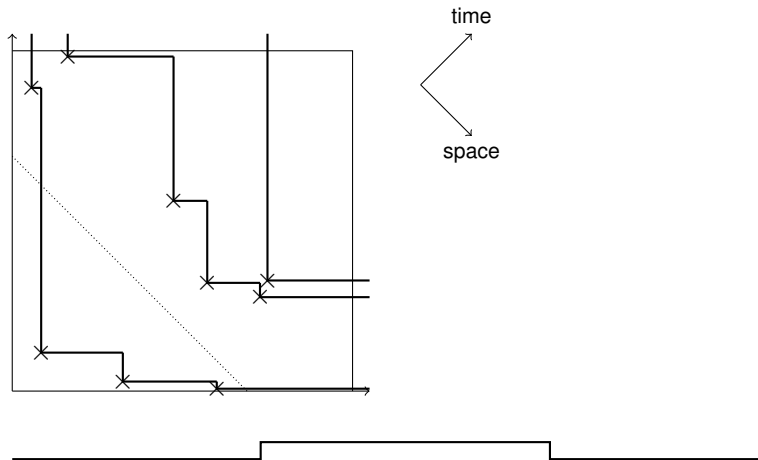

Polynuclear Growth (PNG) [Hammersley '72]

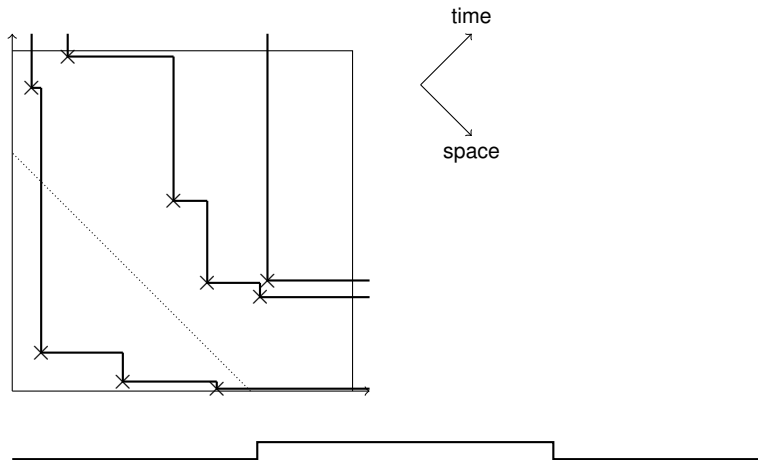

Polynuclear Growth (PNG) [Hammersley '72]

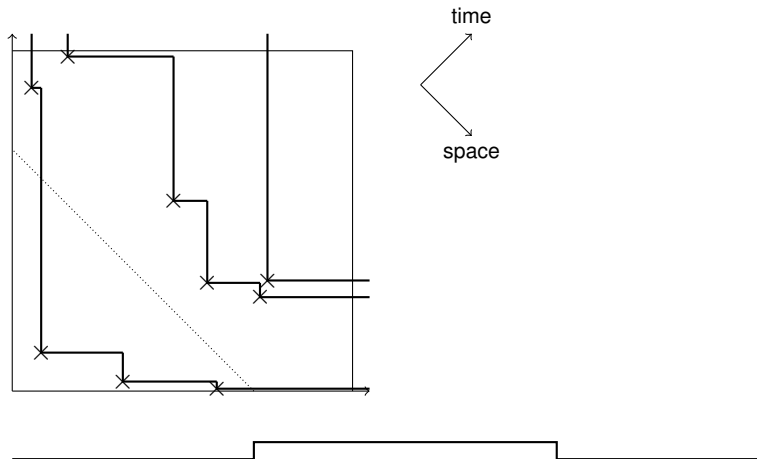

Polynuclear Growth (PNG) [Hammersley '72]

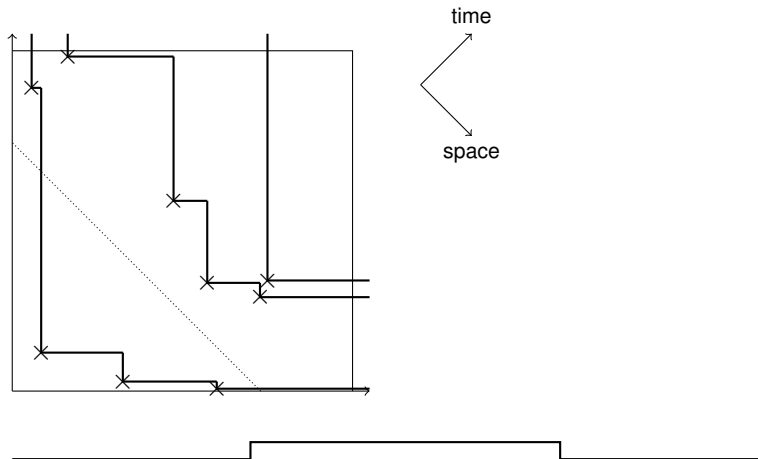

Polynuclear Growth (PNG) [Hammersley '72]

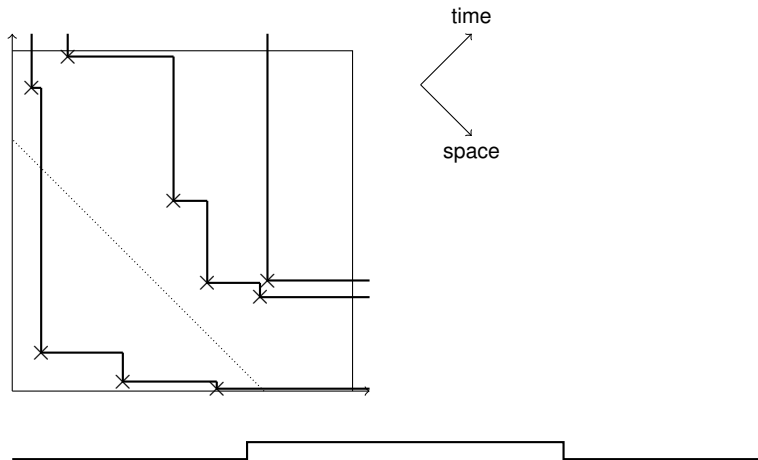

Polynuclear Growth (PNG) [Hammersley '72]

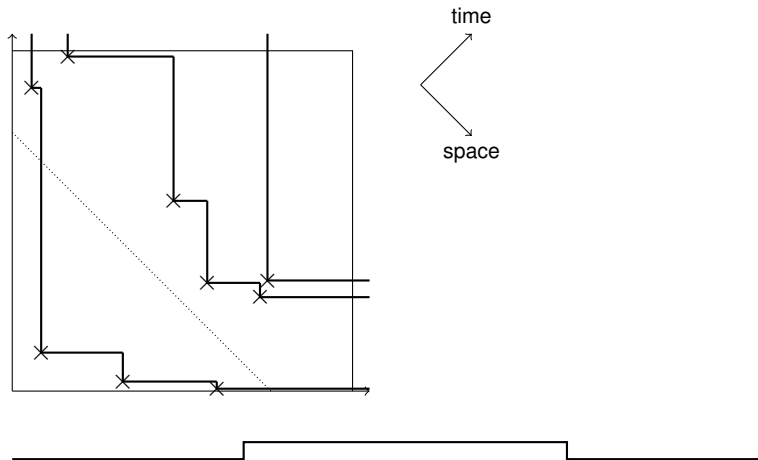

Polynuclear Growth (PNG) [Hammersley '72]

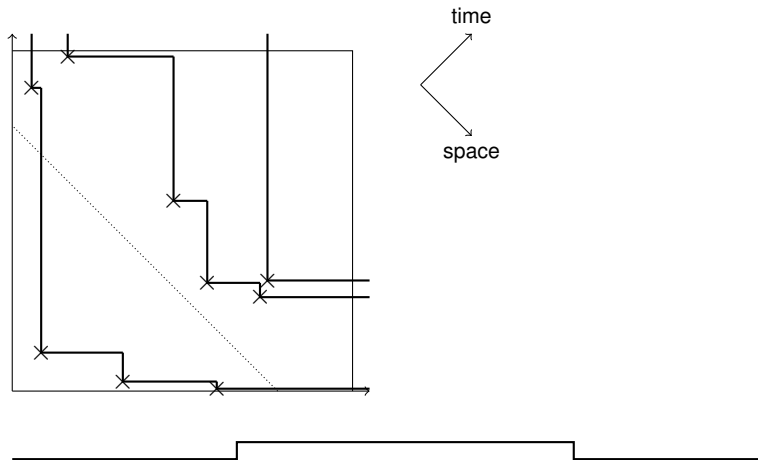

Polynuclear Growth (PNG) [Hammersley '72]

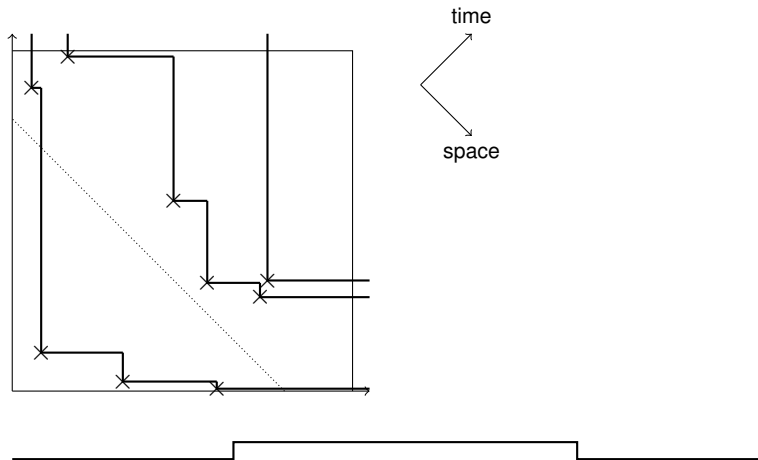

Polynuclear Growth (PNG) [Hammersley '72]

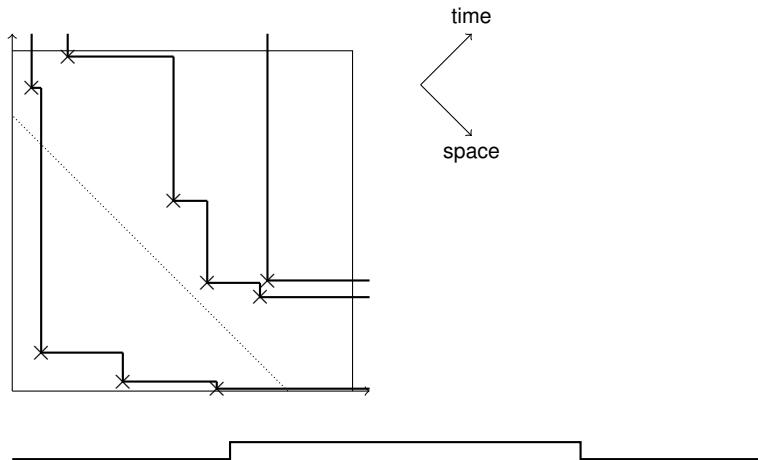

Polynuclear Growth (PNG) [Hammersley '72]

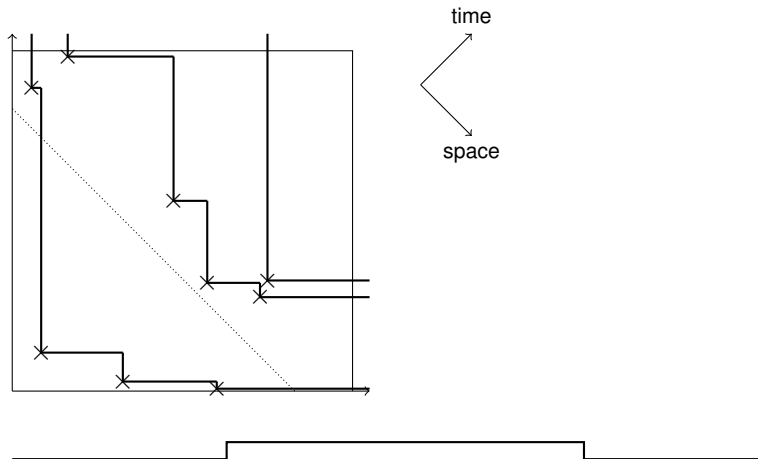

Polynuclear Growth (PNG) [Hammersley '72]

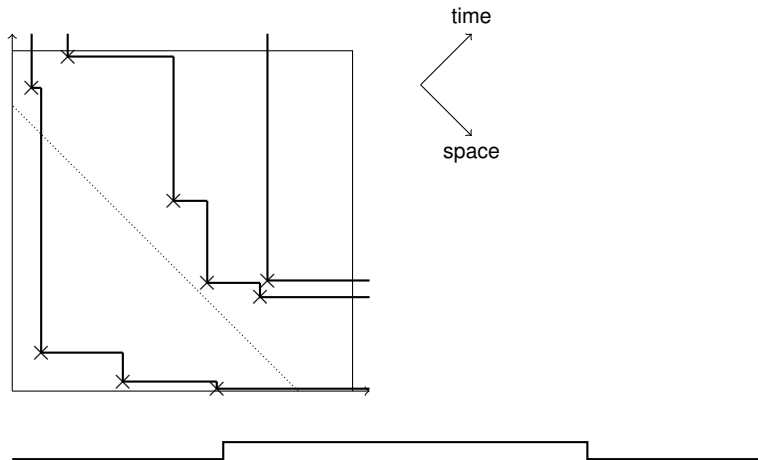

Polynuclear Growth (PNG) [Hammersley '72]

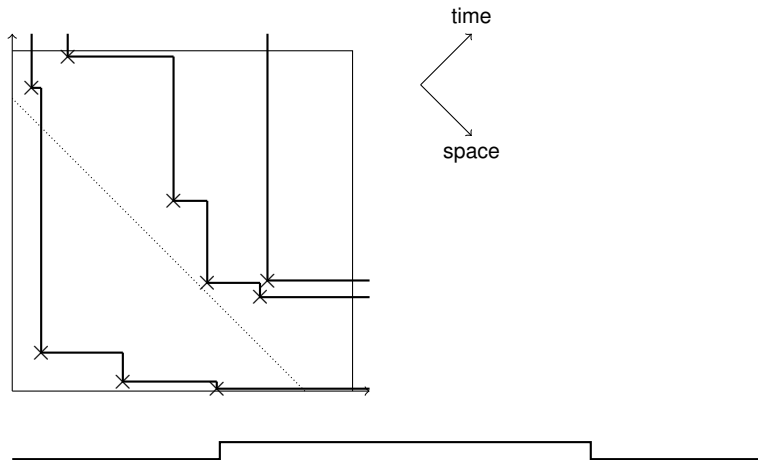

Polynuclear Growth (PNG) [Hammersley '72]

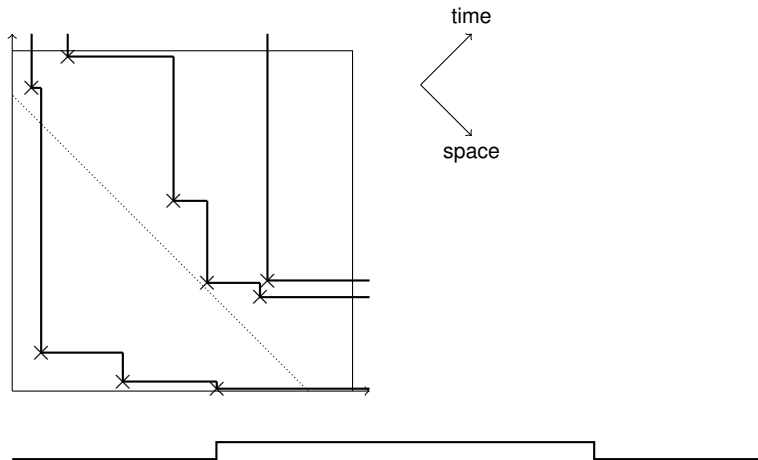

Polynuclear Growth (PNG) [Hammersley '72]

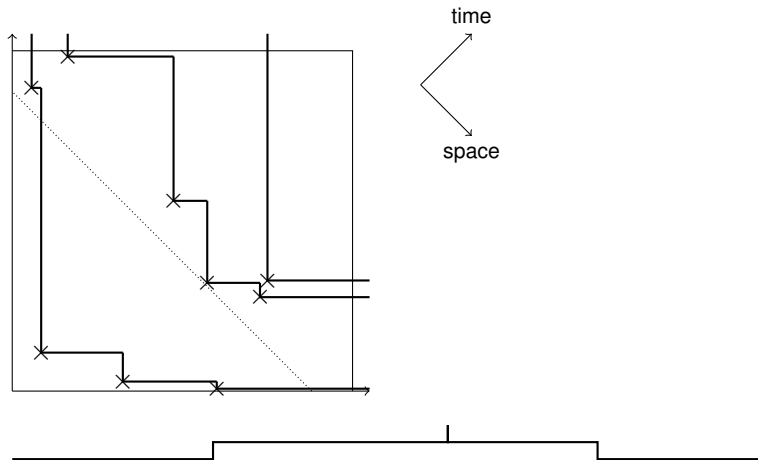

Polynuclear Growth (PNG) [Hammersley '72]

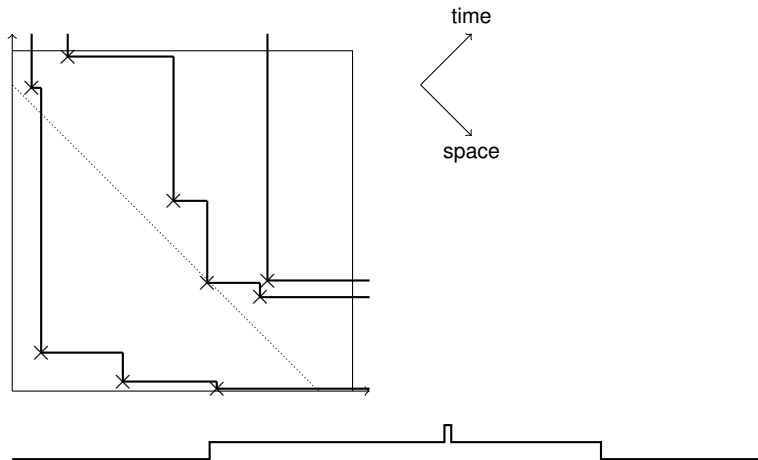

Polynuclear Growth (PNG) [Hammersley '72]

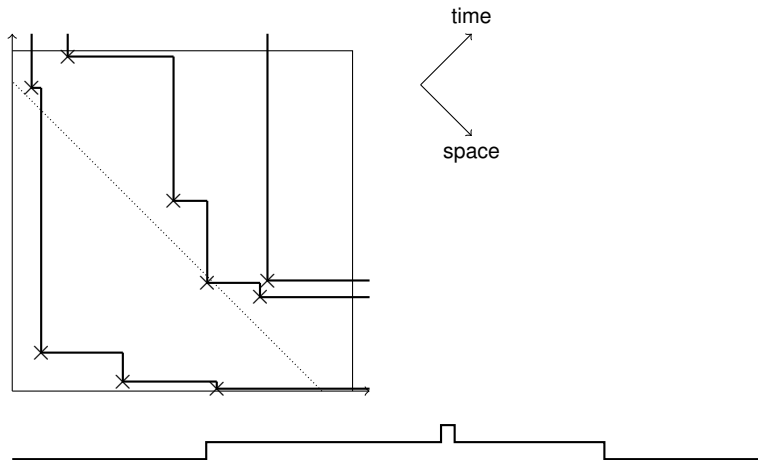

Polynuclear Growth (PNG) [Hammersley '72]

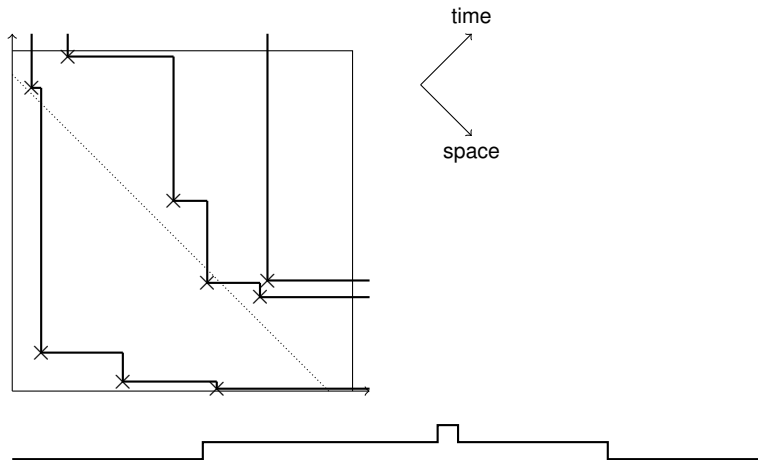

Polynuclear Growth (PNG) [Hammersley '72]

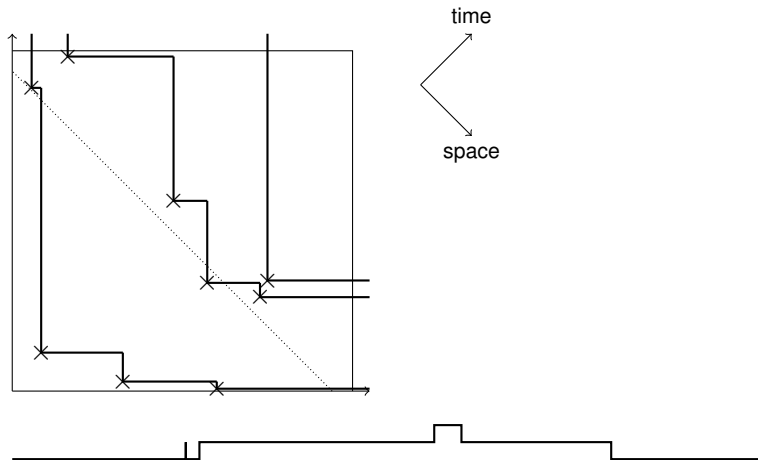

Polynuclear Growth (PNG) [Hammersley '72]

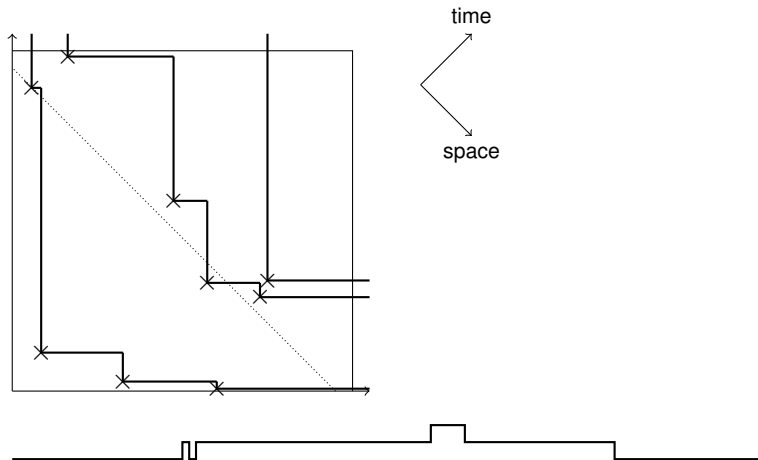

Polynuclear Growth (PNG) [Hammersley '72]

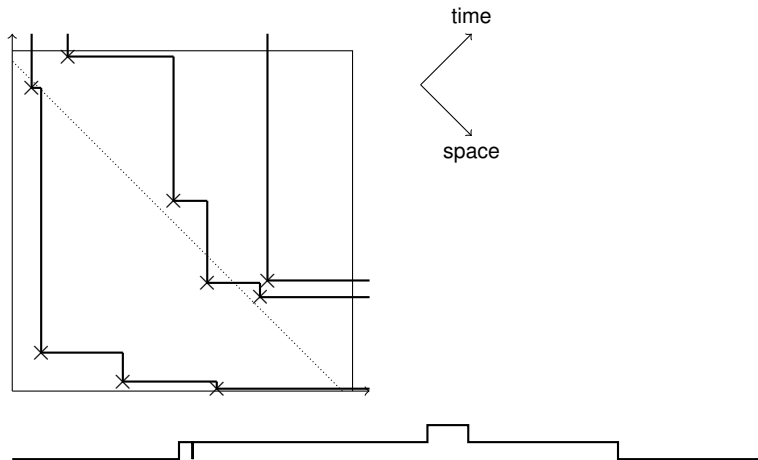

Polynuclear Growth (PNG) [Hammersley '72]

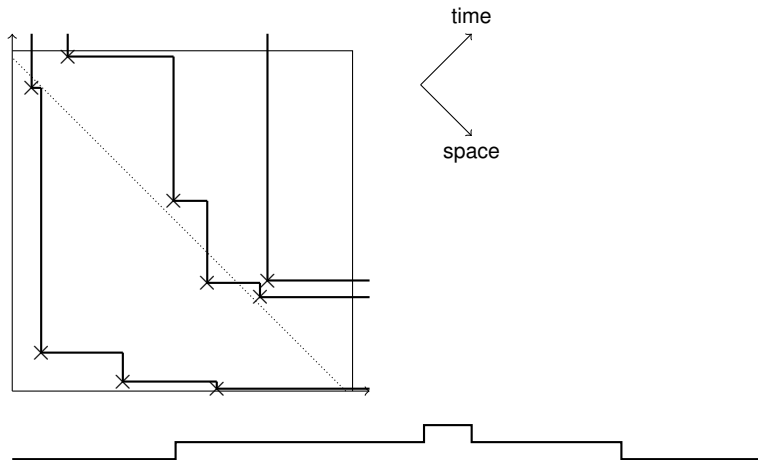

Polynuclear Growth (PNG) [Hammersley '72]

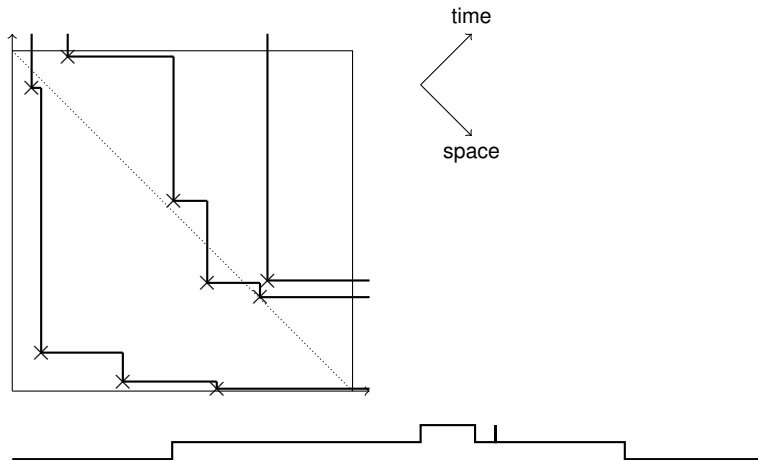

Polynuclear Growth (PNG) [Hammersley '72]

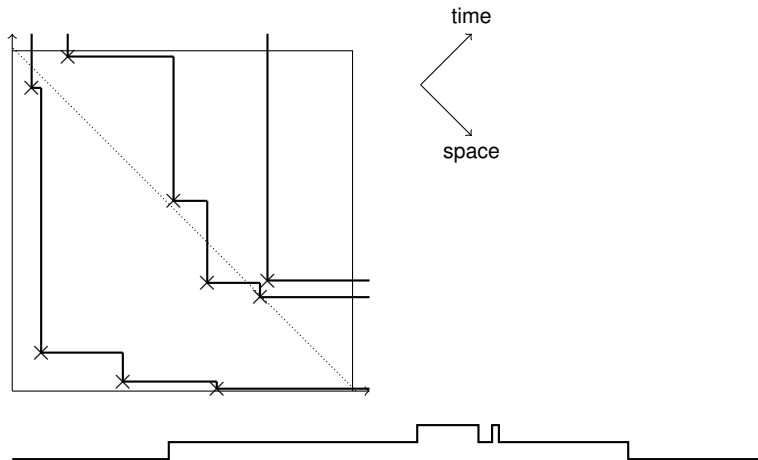

Polynuclear Growth (PNG) [Hammersley '72]

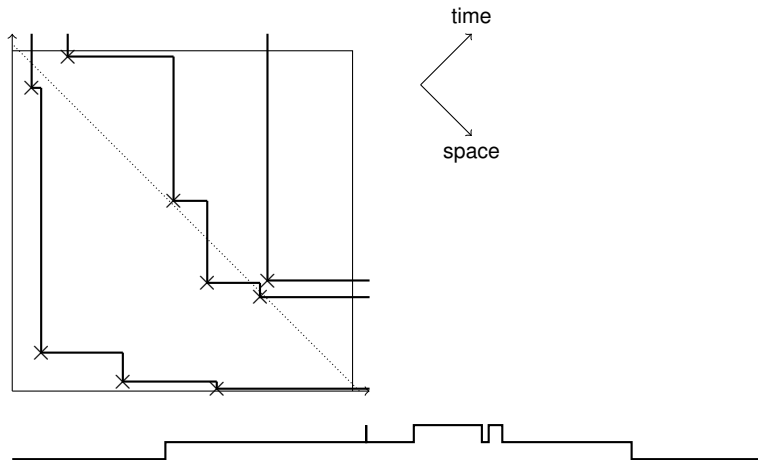

Polynuclear Growth (PNG) [Hammersley '72]

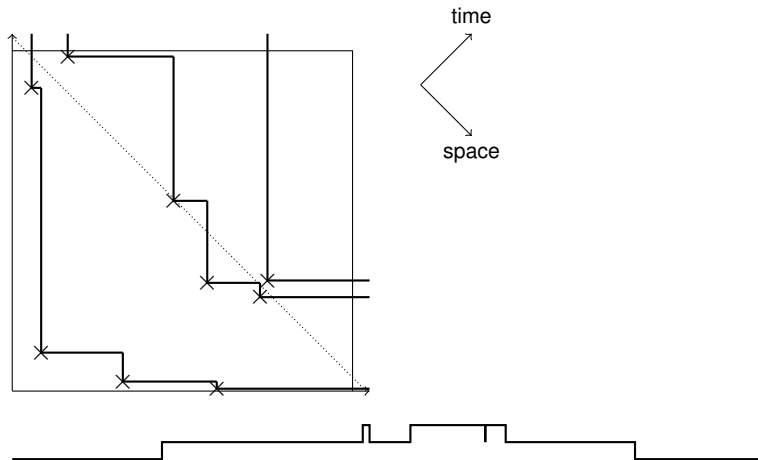

Polynuclear Growth (PNG) [Hammersley '72]

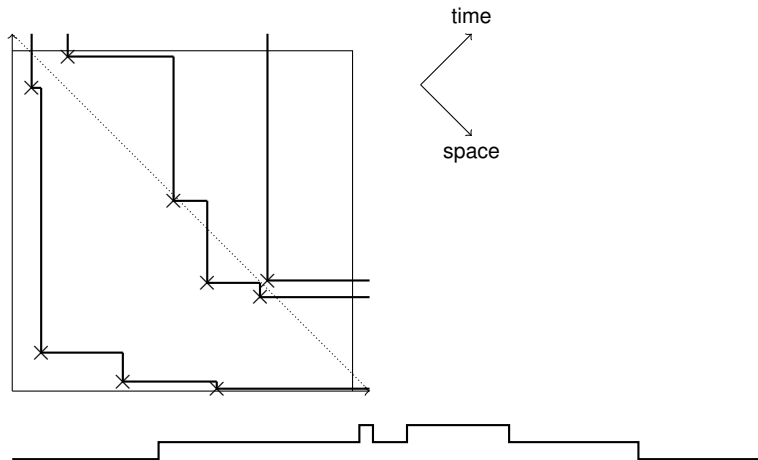

Polynuclear Growth (PNG) [Hammersley '72]

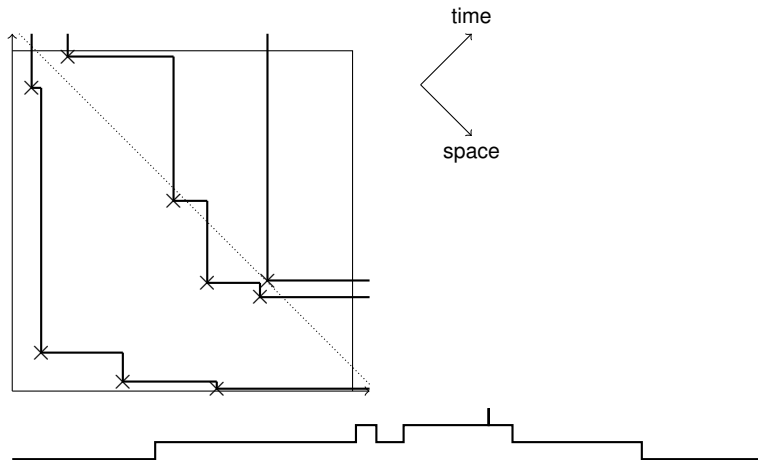

Polynuclear Growth (PNG) [Hammersley '72]

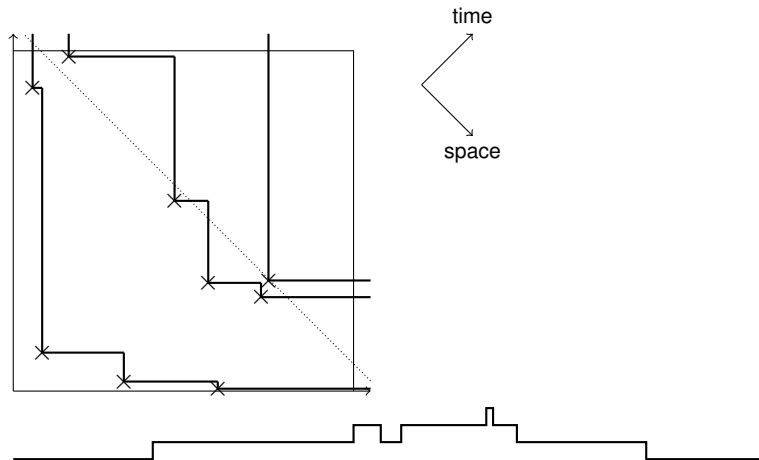

Polynuclear Growth (PNG) [Hammersley '72]

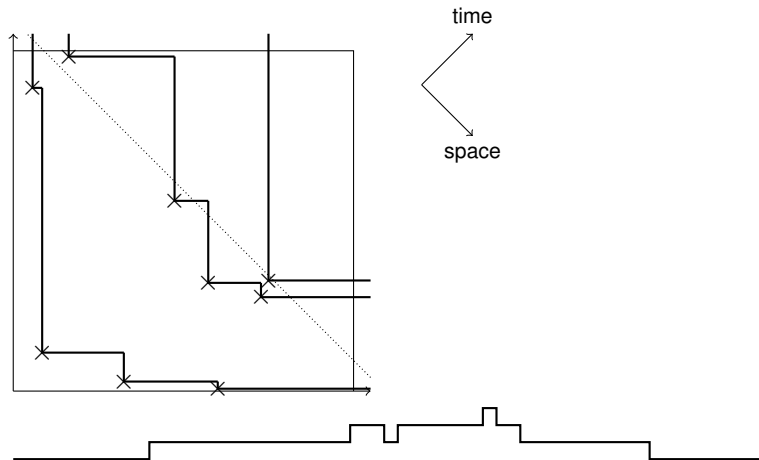

Polynuclear Growth (PNG) [Hammersley '72]

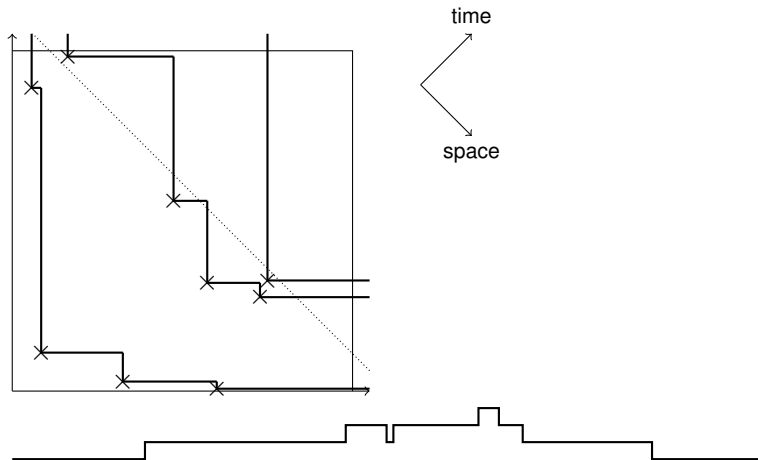

Polynuclear Growth (PNG) [Hammersley '72]

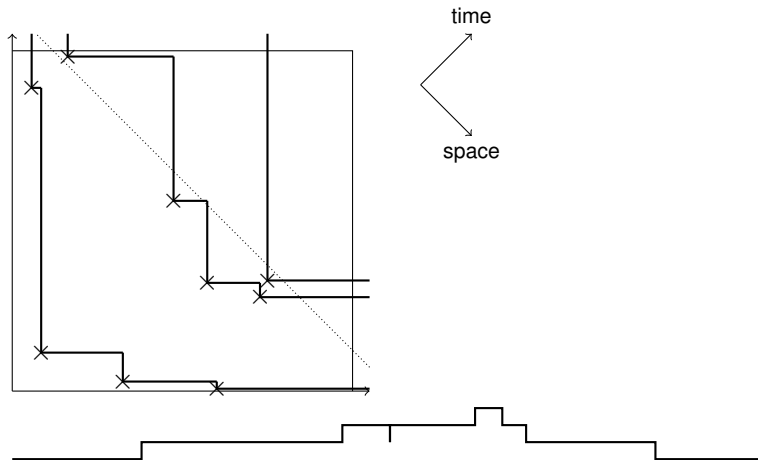

Polynuclear Growth (PNG) [Hammersley '72]

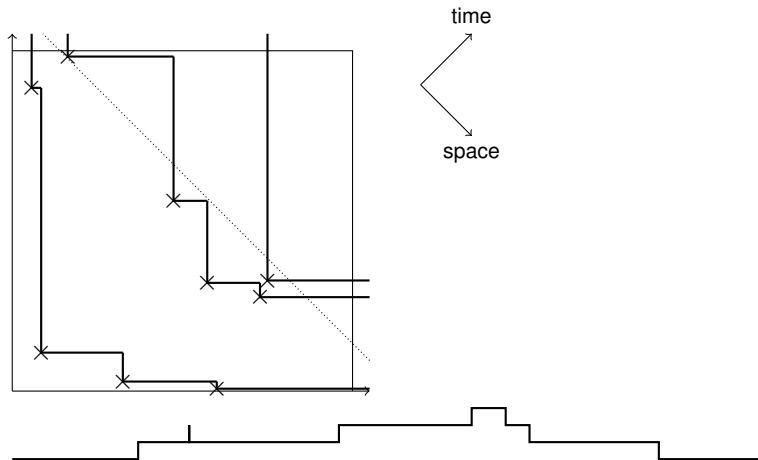

Polynuclear Growth (PNG) [Hammersley '72]

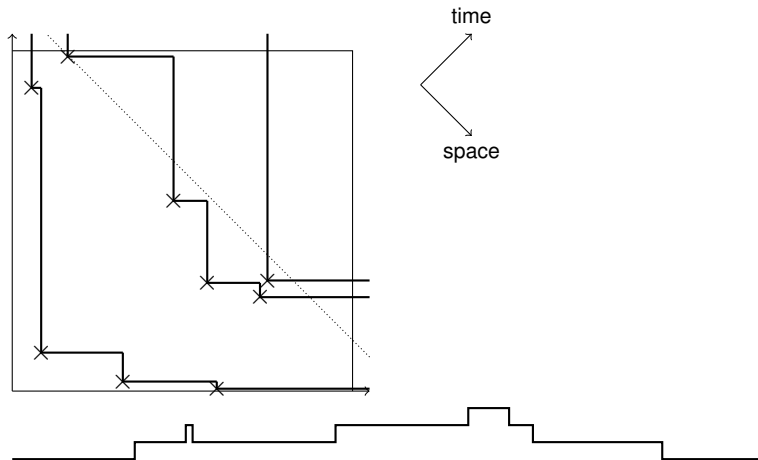

Polynuclear Growth (PNG) [Hammersley '72]

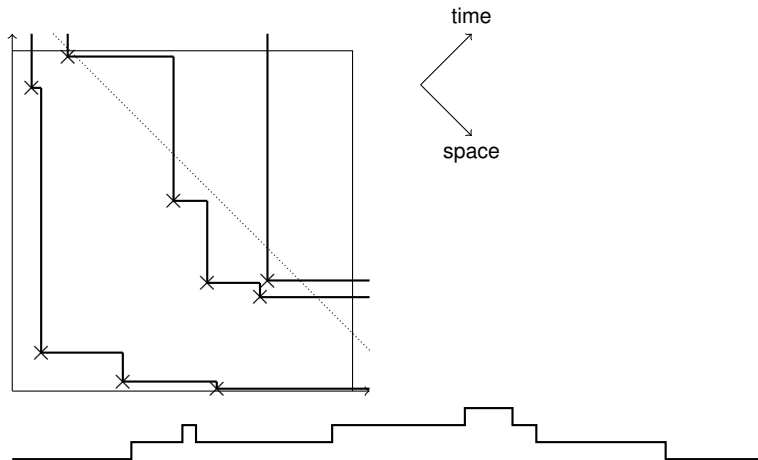

Polynuclear Growth (PNG) [Hammersley '72]

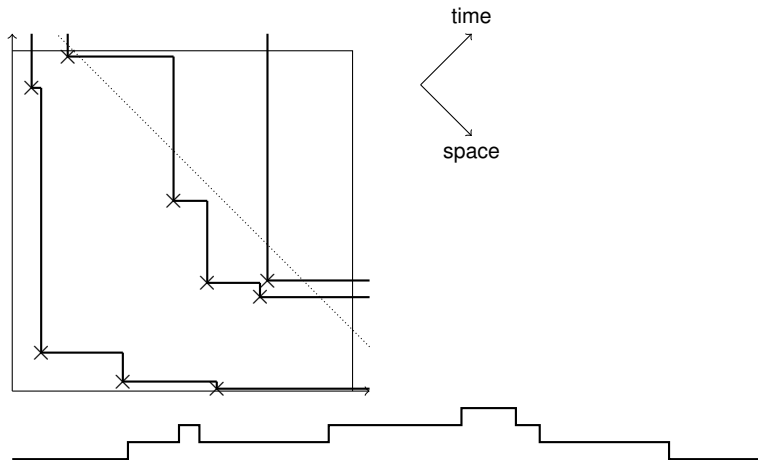

Polynuclear Growth (PNG) [Hammersley '72]

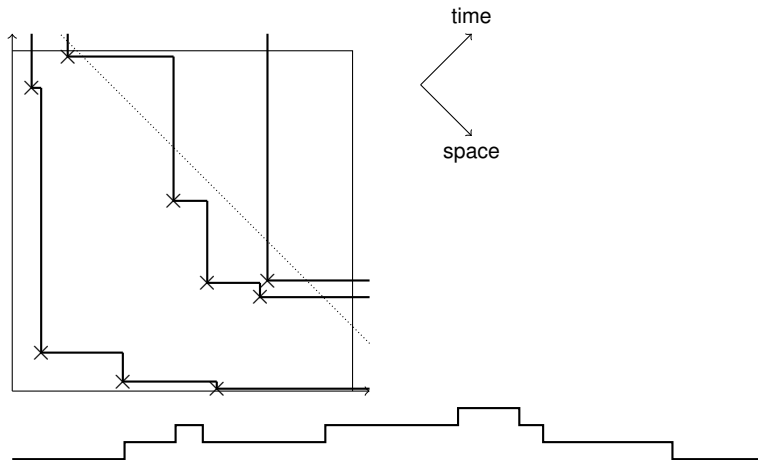

Polynuclear Growth (PNG) [Hammersley '72]

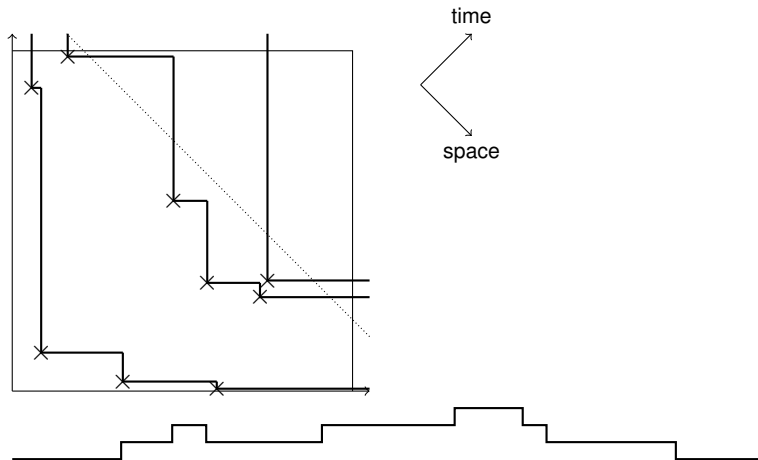

Polynuclear Growth (PNG) [Hammersley '72]

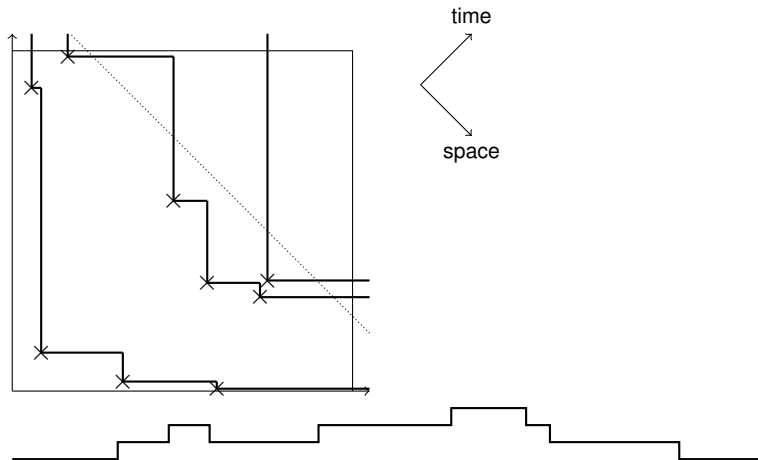

Polynuclear Growth (PNG) [Hammersley '72]

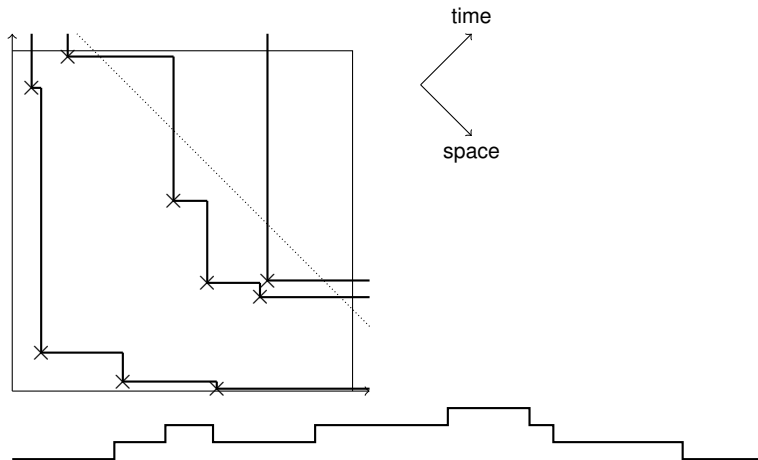

Polynuclear Growth (PNG) [Hammersley '72]

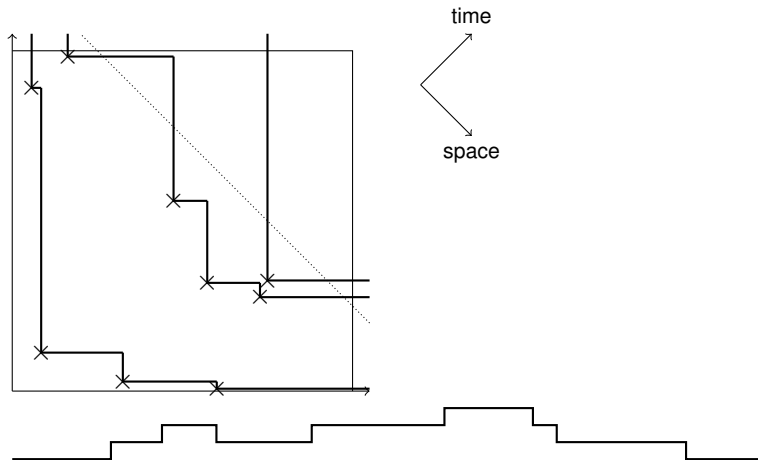

Polynuclear Growth (PNG) [Hammersley '72]

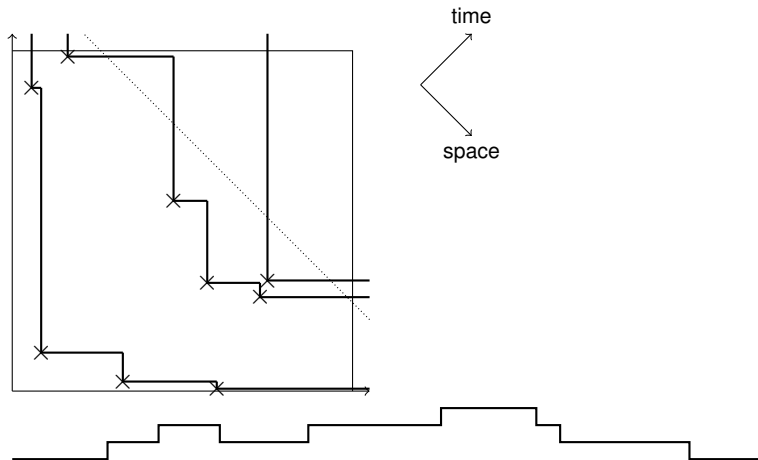

Polynuclear Growth (PNG) [Hammersley '72]

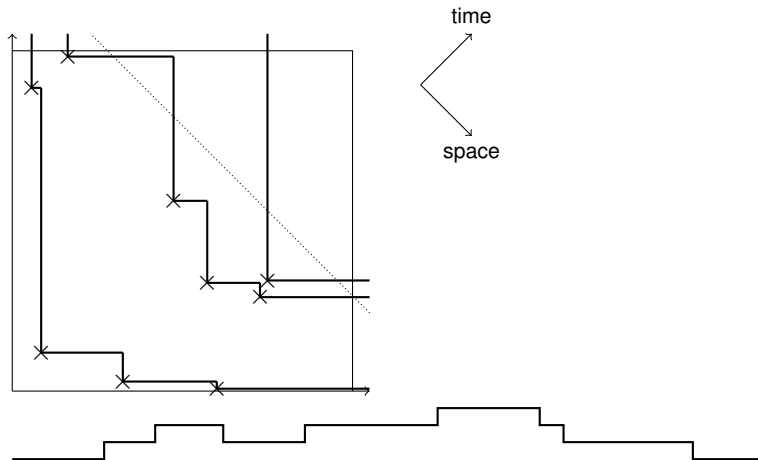

Polynuclear Growth (PNG) [Hammersley '72]

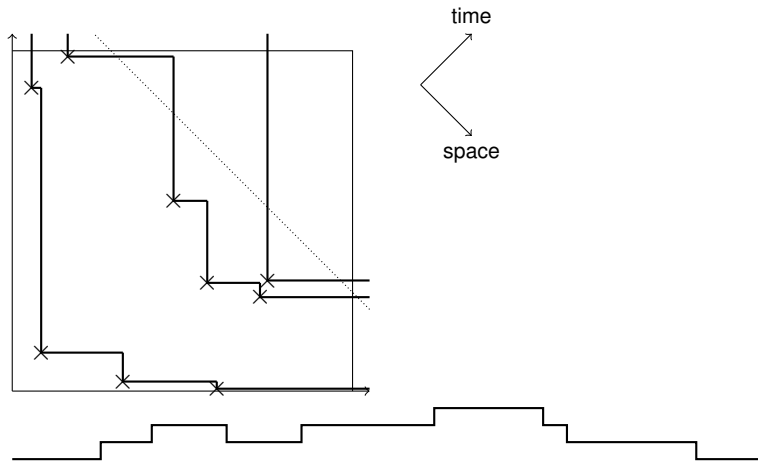

Polynuclear Growth (PNG) [Hammersley '72]

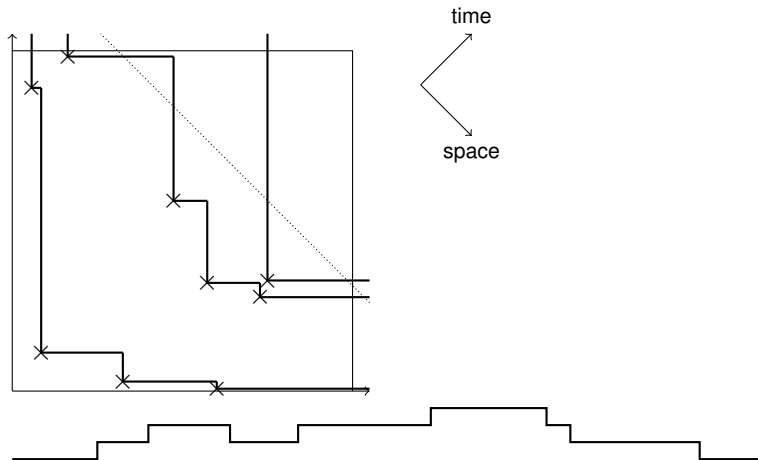

Polynuclear Growth (PNG) [Hammersley '72]

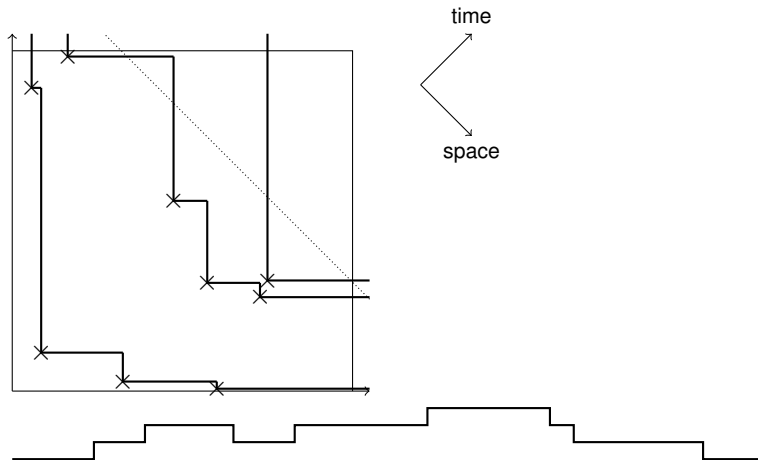

Polynuclear Growth (PNG) [Hammersley '72]

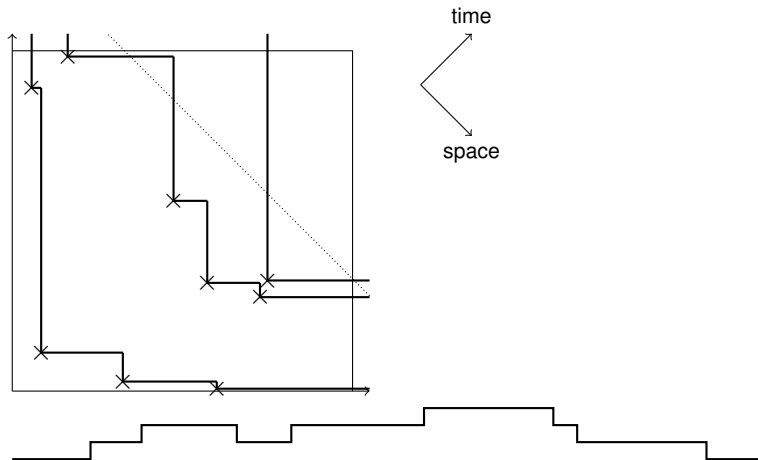

Polynuclear Growth (PNG) [Hammersley '72]

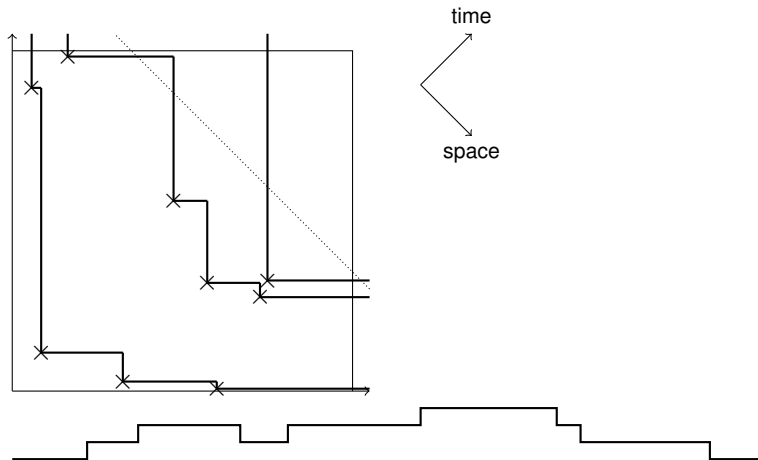

Polynuclear Growth (PNG) [Hammersley '72]

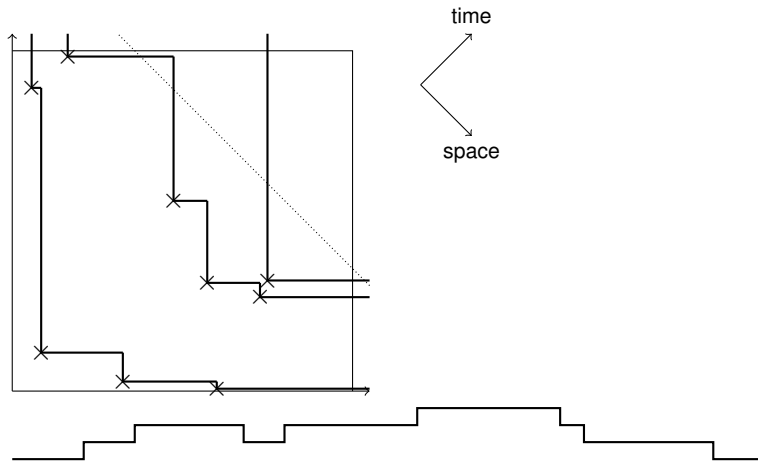

Polynuclear Growth (PNG) [Hammersley '72]

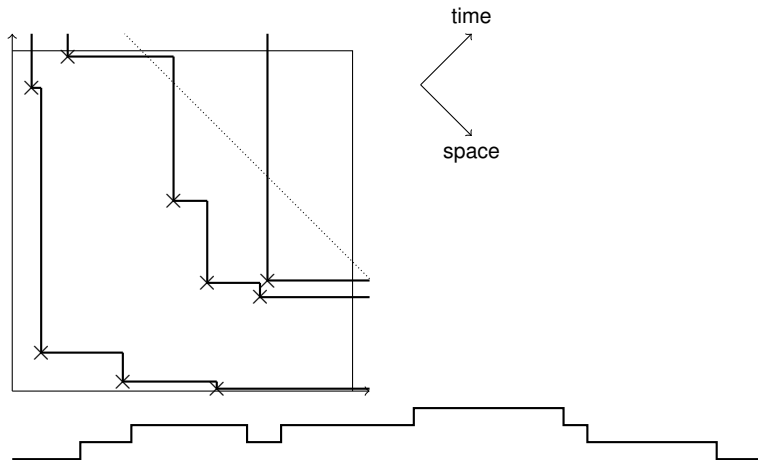

Polynuclear Growth (PNG) [Hammersley '72]

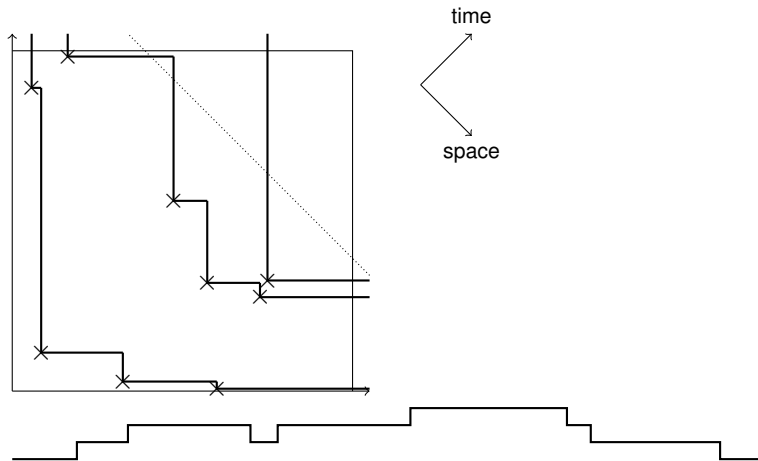

Polynuclear Growth (PNG) [Hammersley '72]

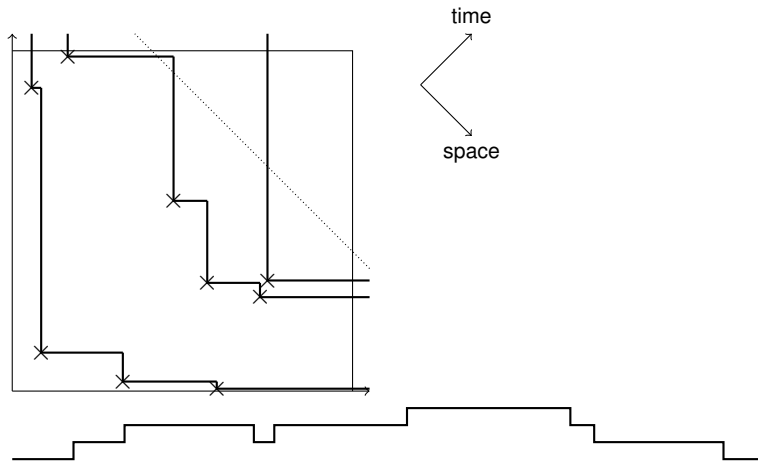

Polynuclear Growth (PNG) [Hammersley '72]

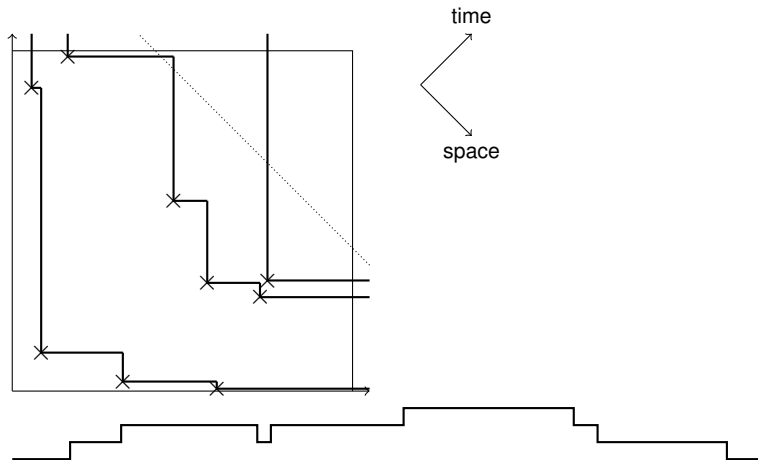

Polynuclear Growth (PNG) [Hammersley '72]

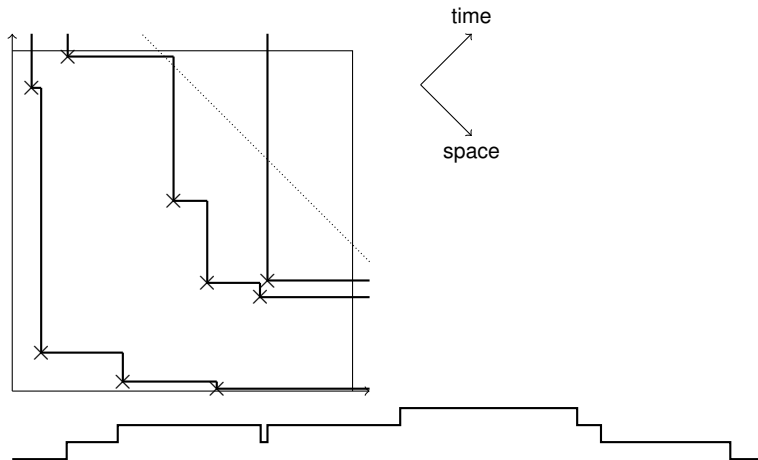

Polynuclear Growth (PNG) [Hammersley '72]

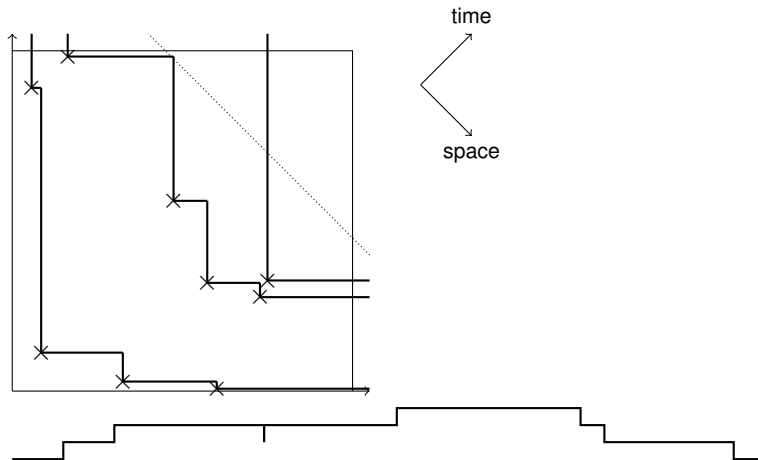

Polynuclear Growth (PNG) [Hammersley '72]

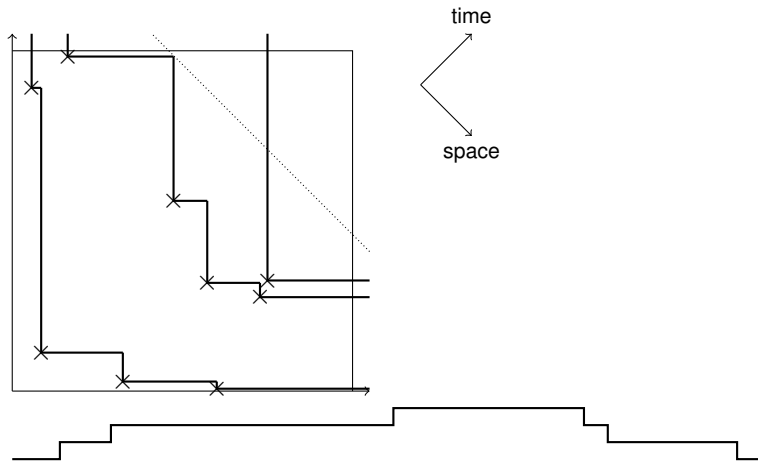

Polynuclear Growth (PNG) [Hammersley '72]

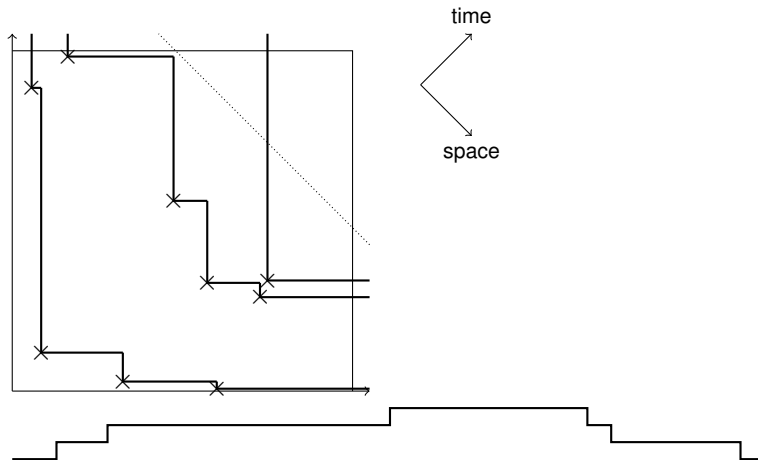

Polynuclear Growth (PNG) [Hammersley '72]

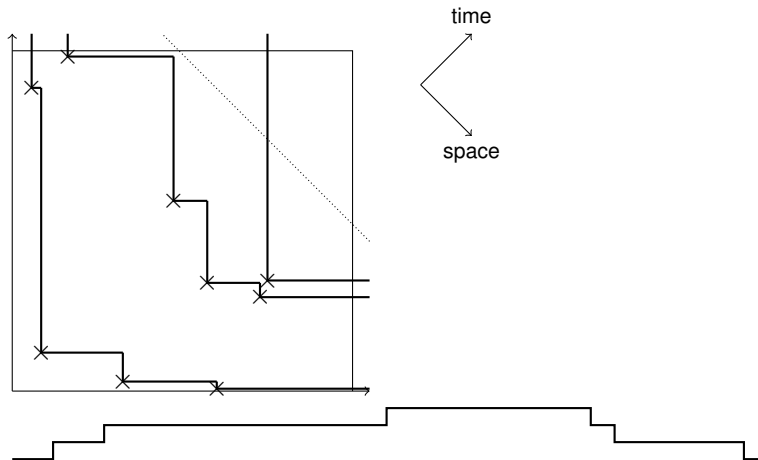

Polynuclear Growth (PNG) [Hammersley '72]

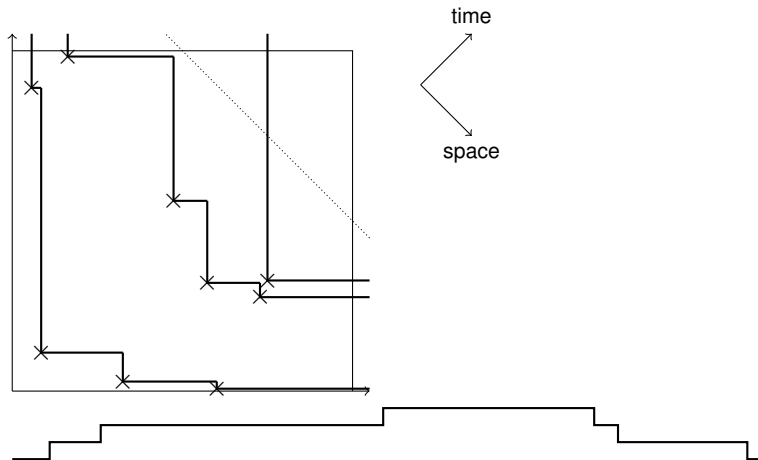

Polynuclear Growth (PNG) [Hammersley '72]

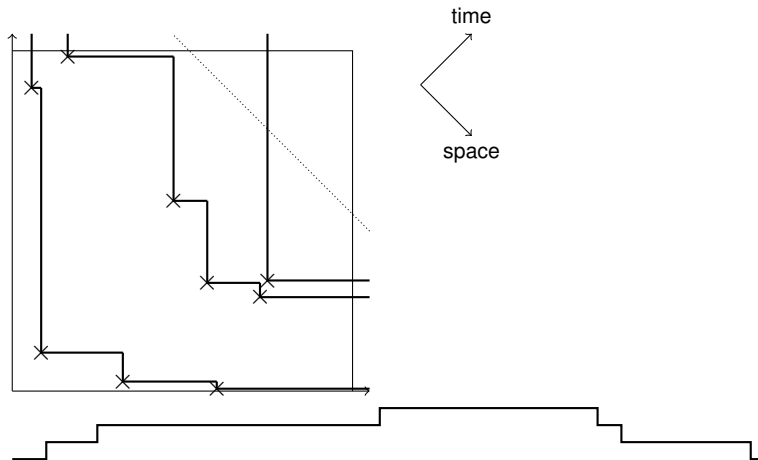

t -PNG [Aggarwal, Borodin, Wheeler '23]

Flip coin: cross with prob. t , corner with prob. $1 - t$.

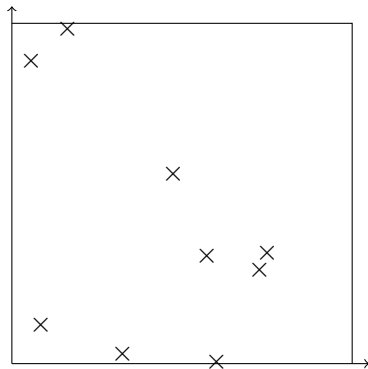

t -PNG [Aggarwal, Borodin, Wheeler '23]

Flip coin: cross with prob. t , corner with prob. $1 - t$.

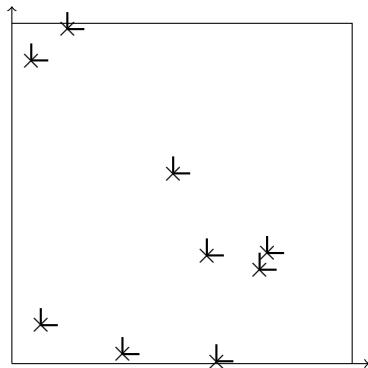

t -PNG [Aggarwal, Borodin, Wheeler '23]

Flip coin: cross with prob. t , corner with prob. $1 - t$.

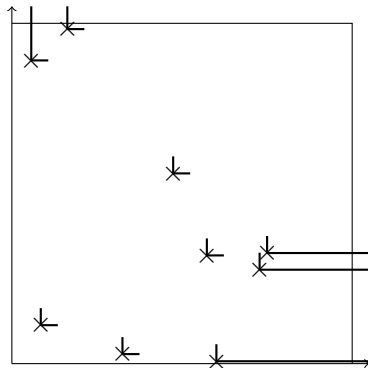

t -PNG [Aggarwal, Borodin, Wheeler '23]

Flip coin: cross with prob. t , corner with prob. $1 - t$.

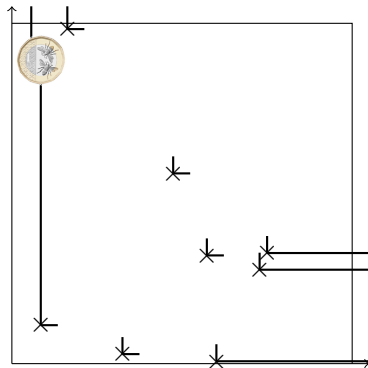

t -PNG [Aggarwal, Borodin, Wheeler '23]

Flip coin: cross with prob. t , corner with prob. $1 - t$.

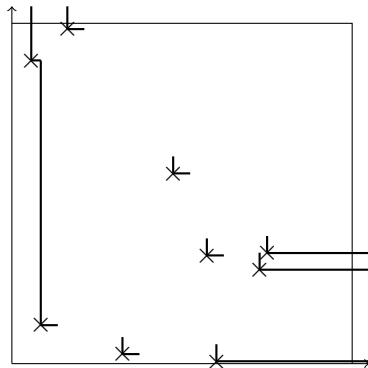

t -PNG [Aggarwal, Borodin, Wheeler '23]

Flip coin: cross with prob. t , corner with prob. $1 - t$.

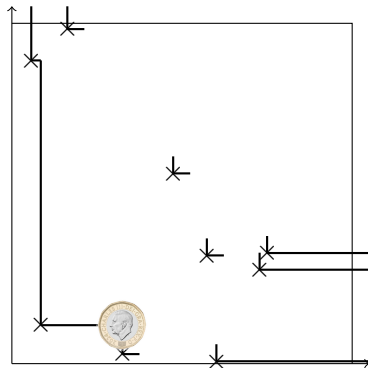

t -PNG [Aggarwal, Borodin, Wheeler '23]

Flip coin: cross with prob. t , corner with prob. $1 - t$.

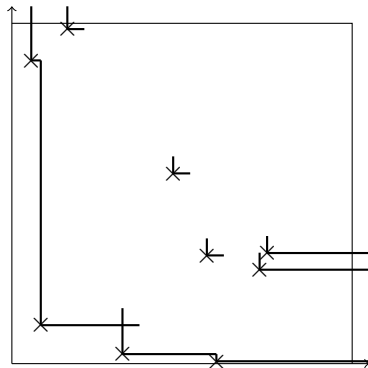

t -PNG [Aggarwal, Borodin, Wheeler '23]

Flip coin: cross with prob. t , corner with prob. $1 - t$.

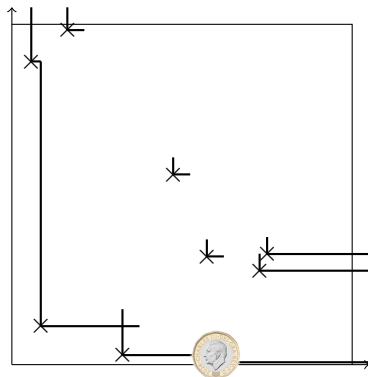

t -PNG [Aggarwal, Borodin, Wheeler '23]

Flip coin: cross with prob. t , corner with prob. $1 - t$.

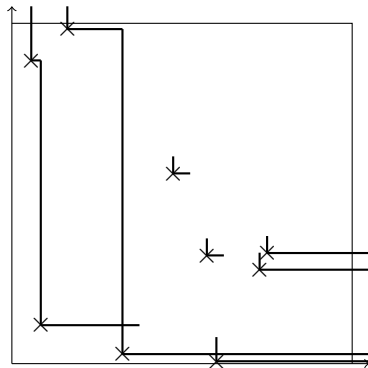

t -PNG [Aggarwal, Borodin, Wheeler '23]

Flip coin: cross with prob. t , corner with prob. $1 - t$.

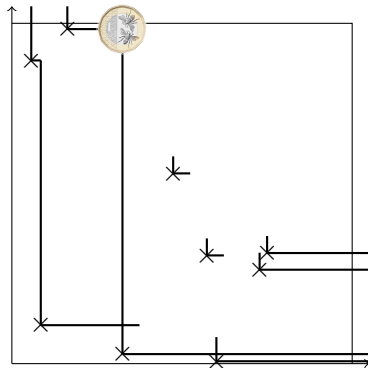

t -PNG [Aggarwal, Borodin, Wheeler '23]

Flip coin: cross with prob. t , corner with prob. $1 - t$.

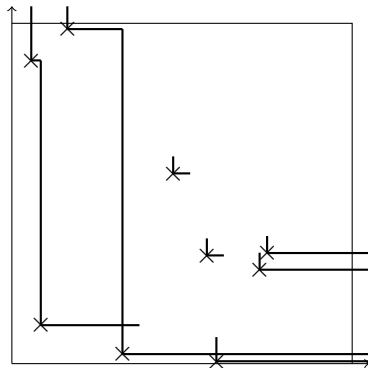

t -PNG [Aggarwal, Borodin, Wheeler '23]

Flip coin: cross with prob. t , corner with prob. $1 - t$.

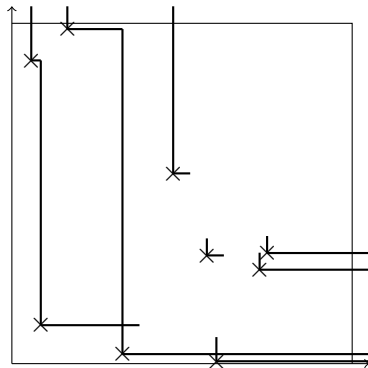

t -PNG [Aggarwal, Borodin, Wheeler '23]

Flip coin: cross with prob. t , corner with prob. $1 - t$.

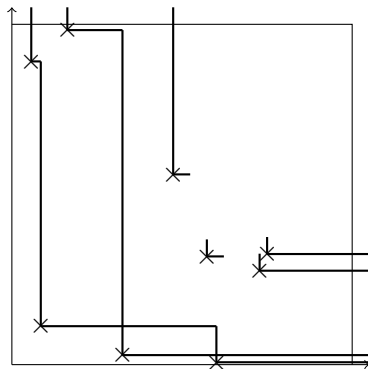

t -PNG [Aggarwal, Borodin, Wheeler '23]

Flip coin: cross with prob. t , corner with prob. $1 - t$.

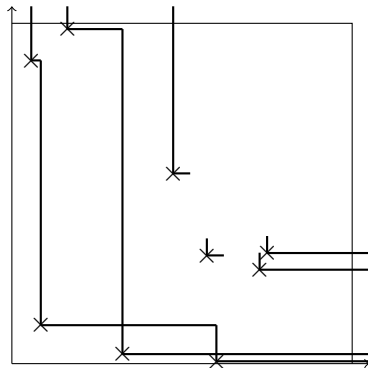

t -PNG [Aggarwal, Borodin, Wheeler '23]

Flip coin: cross with prob. t , corner with prob. $1 - t$.

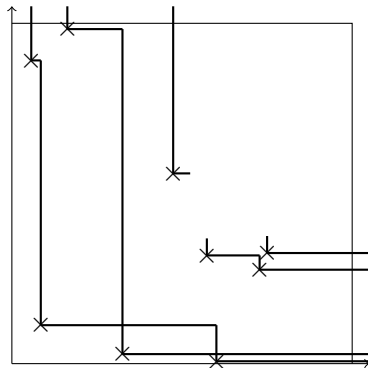

t -PNG [Aggarwal, Borodin, Wheeler '23]

Flip coin: cross with prob. t , corner with prob. $1 - t$.

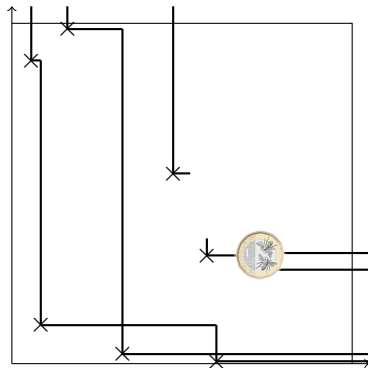

t -PNG [Aggarwal, Borodin, Wheeler '23]

Flip coin: cross with prob. t , corner with prob. $1 - t$.

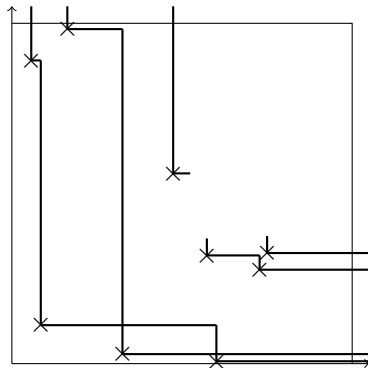

t -PNG [Aggarwal, Borodin, Wheeler '23]

Flip coin: cross with prob. t , corner with prob. $1 - t$.

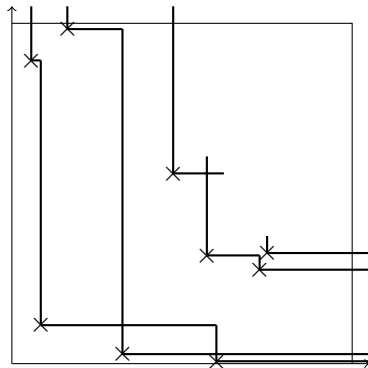

t -PNG [Aggarwal, Borodin, Wheeler '23]

Flip coin: cross with prob. t , corner with prob. $1 - t$.

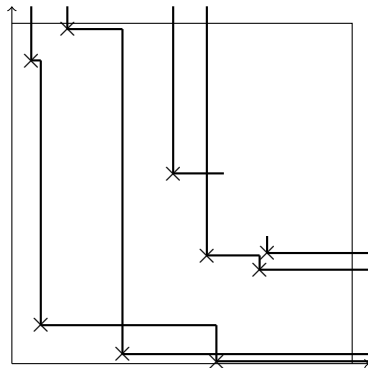

t -PNG [Aggarwal, Borodin, Wheeler '23]

Flip coin: cross with prob. t , corner with prob. $1 - t$.

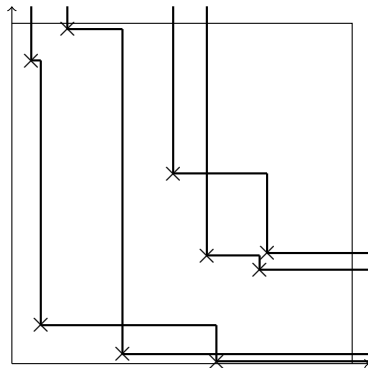

t -PNG [Aggarwal, Borodin, Wheeler '23]

Flip coin: cross with prob. t , corner with prob. $1 - t$.

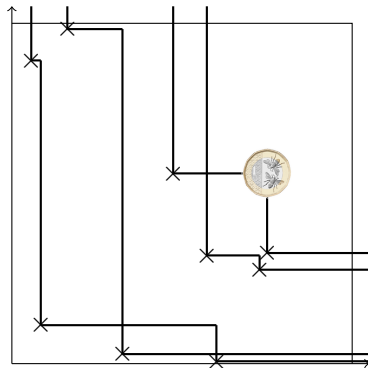

t -PNG [Aggarwal, Borodin, Wheeler '23]

Flip coin: cross with prob. t , corner with prob. $1 - t$.

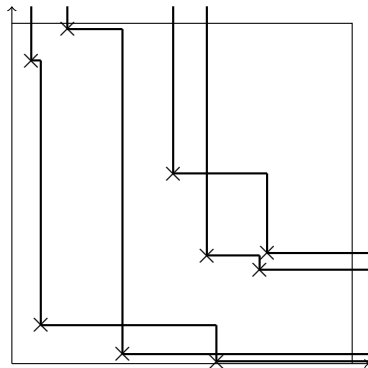

t -PNG [Aggarwal, Borodin, Wheeler '23]

Flip coin: cross with prob. t , corner with prob. $1 - t$.

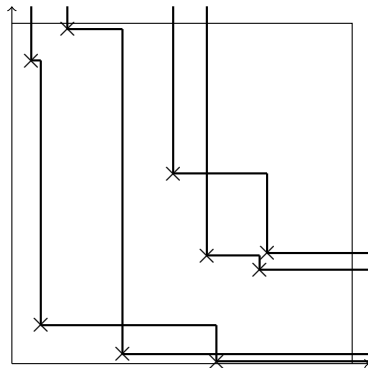

- ▶ Fluctuations: in KPZ-class [Aggarwal, Borodin, Wheeler '23]
- ▶ Colliding nucleations don't always annihilate (coin)

Stationary t -PNG [Drillick, Lin '24]

Flip coin: cross with prob. t , corner with prob. $1 - t$.

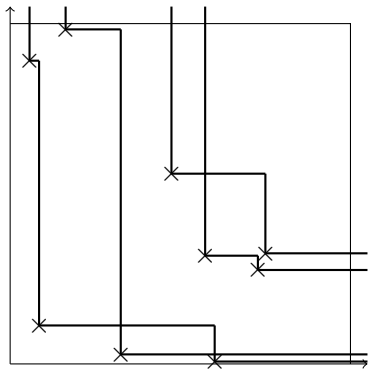

Stationary t -PNG [Drillick, Lin '24]

Flip coin: cross with prob. t , corner with prob. $1 - t$.

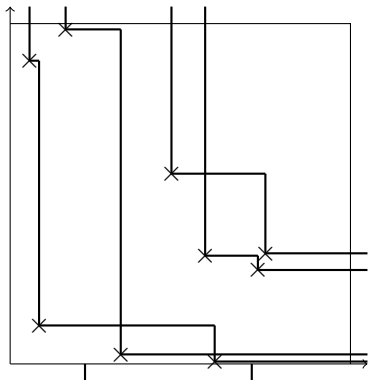

- Add **sources** on the bottom, and

Stationary t -PNG [Drillick, Lin '24]

Flip coin: cross with prob. t , corner with prob. $1 - t$.

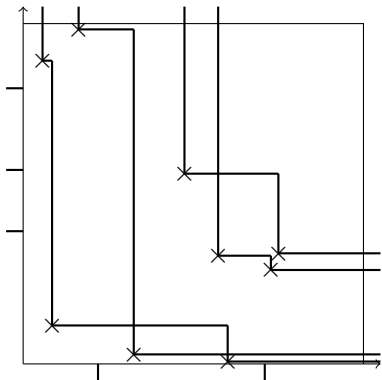

- ▶ Add **sources** on the bottom, and
- ▶ **sinks** on the left.

Stationary t -PNG [Drillick, Lin '24]

Flip coin: cross with prob. t , corner with prob. $1 - t$.

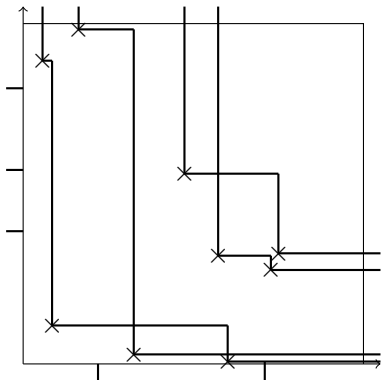

- ▶ Add **sources** on the bottom, and
- ▶ **sinks** on the left.

Stationary t -PNG [Drillick, Lin '24]

Flip coin: cross with prob. t , corner with prob. $1 - t$.

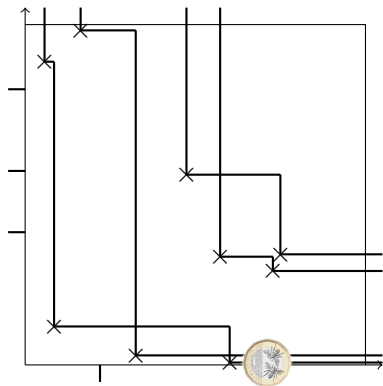

- ▶ Add **sources** on the bottom, and
- ▶ **sinks** on the left.

Stationary t -PNG [Drillick, Lin '24]

Flip coin: cross with prob. t , corner with prob. $1 - t$.

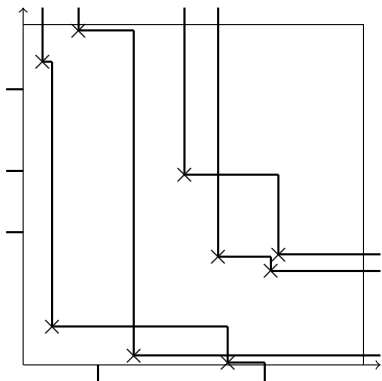

- ▶ Add **sources** on the bottom, and
- ▶ **sinks** on the left.

Stationary t -PNG [Drillick, Lin '24]

Flip coin: cross with prob. t , corner with prob. $1 - t$.

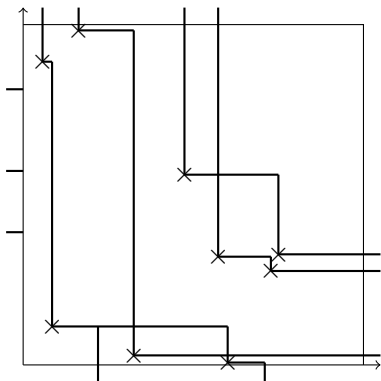

- ▶ Add **sources** on the bottom, and
- ▶ **sinks** on the left.

Stationary t -PNG [Drillick, Lin '24]

Flip coin: cross with prob. t , corner with prob. $1 - t$.

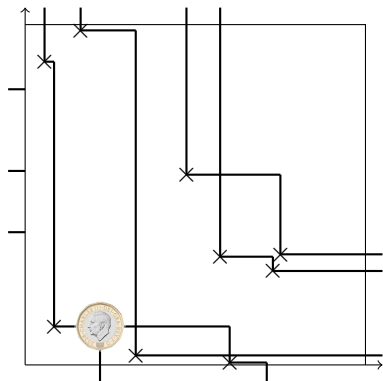

- ▶ Add **sources** on the bottom, and
- ▶ **sinks** on the left.

Stationary t -PNG [Drillick, Lin '24]

Flip coin: cross with prob. t , corner with prob. $1 - t$.

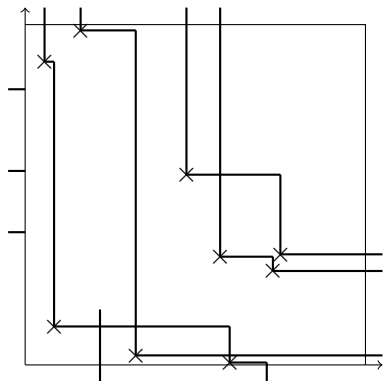

- ▶ Add **sources** on the bottom, and
- ▶ **sinks** on the left.

Stationary t -PNG [Drillick, Lin '24]

Flip coin: cross with prob. t , corner with prob. $1 - t$.

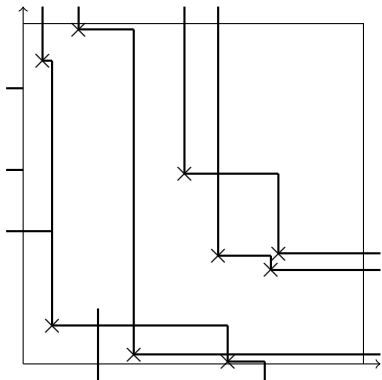

- ▶ Add **sources** on the bottom, and
- ▶ **sinks** on the left.

Stationary t -PNG [Drillick, Lin '24]

Flip coin: cross with prob. t , corner with prob. $1 - t$.

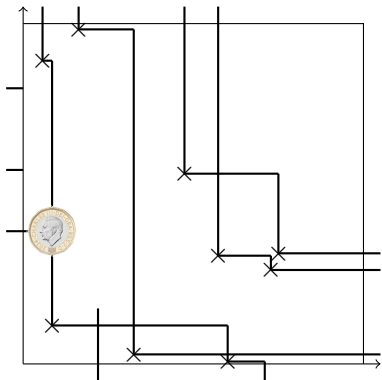

- ▶ Add **sources** on the bottom, and
- ▶ **sinks** on the left.

Stationary t -PNG [Drillick, Lin '24]

Flip coin: cross with prob. t , corner with prob. $1 - t$.

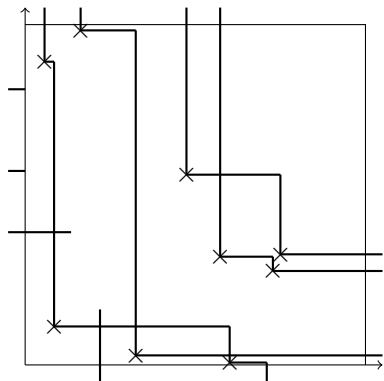

- ▶ Add **sources** on the bottom, and
- ▶ **sinks** on the left.

Stationary t -PNG [Drillick, Lin '24]

Flip coin: cross with prob. t , corner with prob. $1 - t$.

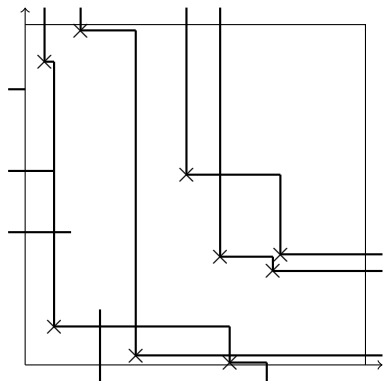

- ▶ Add **sources** on the bottom, and
- ▶ **sinks** on the left.

Stationary t -PNG [Drillick, Lin '24]

Flip coin: cross with prob. t , corner with prob. $1 - t$.

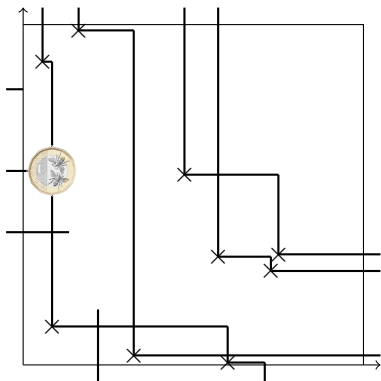

- ▶ Add **sources** on the bottom, and
- ▶ **sinks** on the left.

Stationary t -PNG [Drillick, Lin '24]

Flip coin: cross with prob. t , corner with prob. $1 - t$.

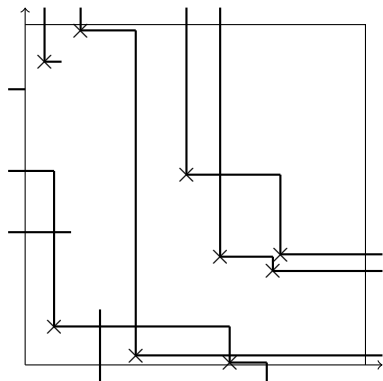

- ▶ Add **sources** on the bottom, and
- ▶ **sinks** on the left.

Stationary t -PNG [Drillick, Lin '24]

Flip coin: cross with prob. t , corner with prob. $1 - t$.

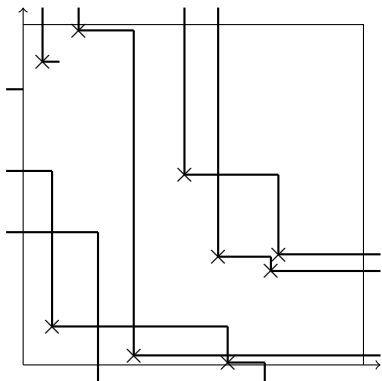

- ▶ Add **sources** on the bottom, and
- ▶ **sinks** on the left.

Stationary t -PNG [Drillick, Lin '24]

Flip coin: cross with prob. t , corner with prob. $1 - t$.

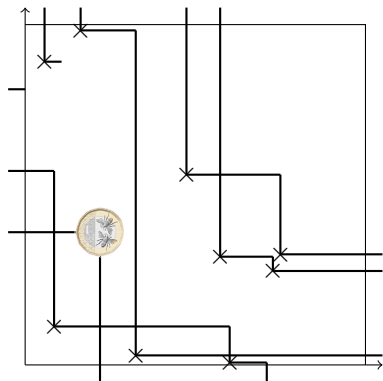

- ▶ Add **sources** on the bottom, and
- ▶ **sinks** on the left.

Stationary t -PNG [Drillick, Lin '24]

Flip coin: cross with prob. t , corner with prob. $1 - t$.

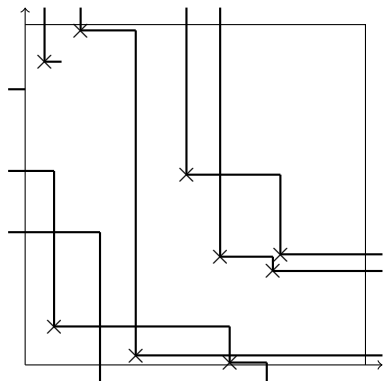

- ▶ Add **sources** on the bottom, and
- ▶ **sinks** on the left.

Stationary t -PNG [Drillick, Lin '24]

Flip coin: cross with prob. t , corner with prob. $1 - t$.

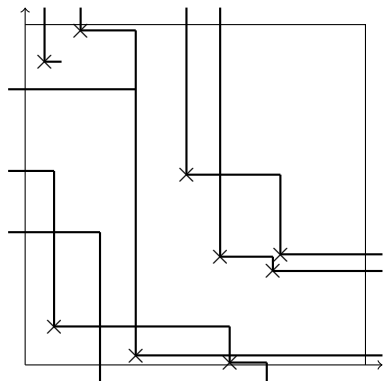

- ▶ Add **sources** on the bottom, and
- ▶ **sinks** on the left.

Stationary t -PNG [Drillick, Lin '24]

Flip coin: cross with prob. t , corner with prob. $1 - t$.

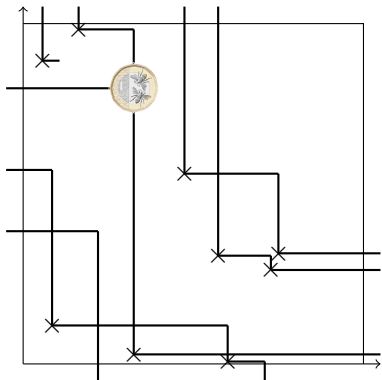

- ▶ Add **sources** on the bottom, and
- ▶ **sinks** on the left.

Stationary t -PNG [Drillick, Lin '24]

Flip coin: cross with prob. t , corner with prob. $1 - t$.

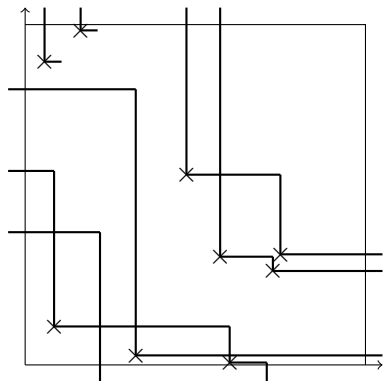

- ▶ Add **sources** on the bottom, and
- ▶ **sinks** on the left.

Stationary t -PNG [Drillick, Lin '24]

Flip coin: cross with prob. t , corner with prob. $1 - t$.

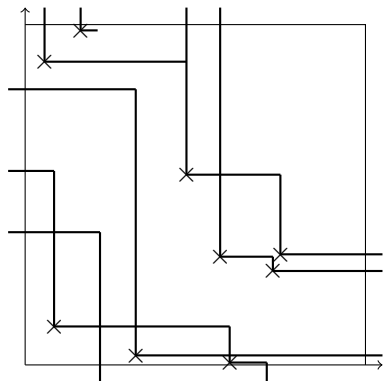

- ▶ Add **sources** on the bottom, and
- ▶ **sinks** on the left.

Stationary t -PNG [Drillick, Lin '24]

Flip coin: cross with prob. t , corner with prob. $1 - t$.

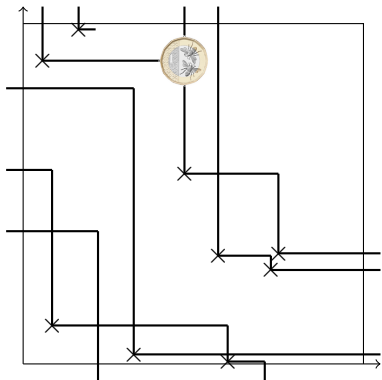

- ▶ Add **sources** on the bottom, and
- ▶ **sinks** on the left.

Stationary t -PNG [Drillick, Lin '24]

Flip coin: cross with prob. t , corner with prob. $1 - t$.

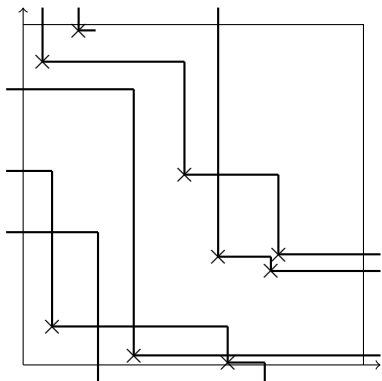

- ▶ Add **sources** on the bottom, and
- ▶ **sinks** on the left.

Stationary t -PNG [Drillick, Lin '24]

Flip coin: cross with prob. t , corner with prob. $1 - t$.

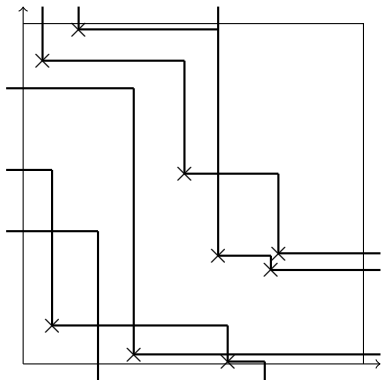

- ▶ Add **sources** on the bottom, and
- ▶ **sinks** on the left.

Stationary t -PNG [Drillick, Lin '24]

Flip coin: cross with prob. t , corner with prob. $1 - t$.

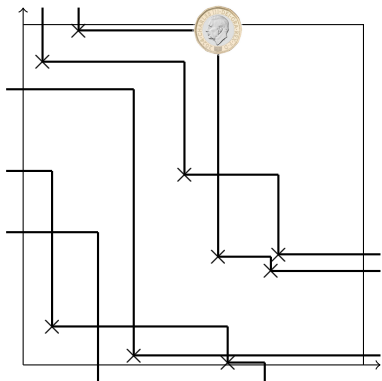

- ▶ Add **sources** on the bottom, and
- ▶ **sinks** on the left.

Stationary t -PNG [Drillick, Lin '24]

Flip coin: cross with prob. t , corner with prob. $1 - t$.

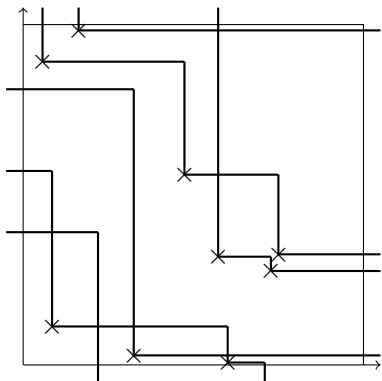

- ▶ Add **sources** on the bottom, and
- ▶ **sinks** on the left.

Stationary t -PNG [Drillick, Lin '24]

Flip coin: cross with prob. t , corner with prob. $1 - t$.

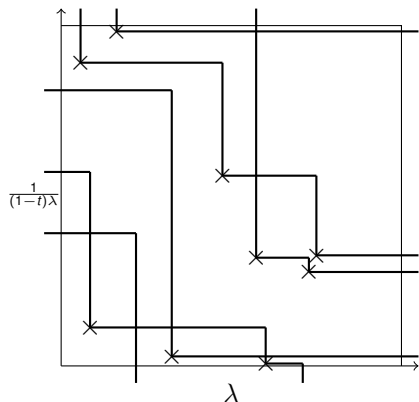

- ▶ Add **sources** on the bottom, and
- ▶ **sinks** on the left.

Theorem

- ▶ If *sources* $\sim \text{Poi}(\lambda)$, and
- ▶ *sinks* $\sim \text{Poi}(\frac{1}{(1-t)\lambda})$ independent,

Stationary t -PNG [Drillick, Lin '24]

Flip coin: cross with prob. t , corner with prob. $1 - t$.

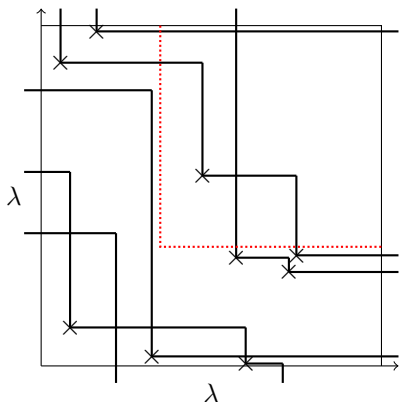

- ▶ Add **sources** on the bottom, and
- ▶ **sinks** on the left.

Theorem

- ▶ If *sources* $\sim \text{Poi}(\lambda)$, and
- ▶ *sinks* $\sim \text{Poi}\left(\frac{1}{(1-t)\lambda}\right)$ independent,

then lines entering

- ▶ on the bottom $\sim \text{Poi}(\lambda)$
- ▶ on the left $\sim \text{Poi}\left(\frac{1}{(1-t)\lambda}\right)$, independent.

Local convergence

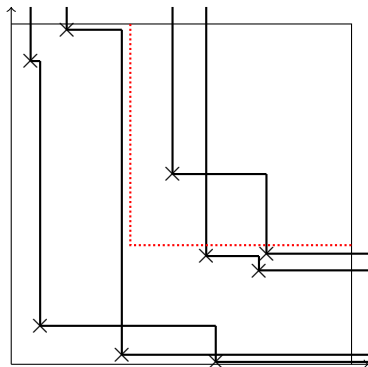

Local convergence

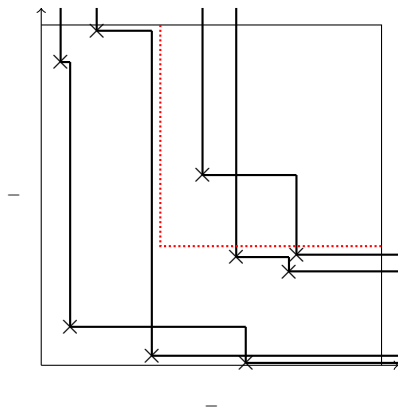

Local convergence

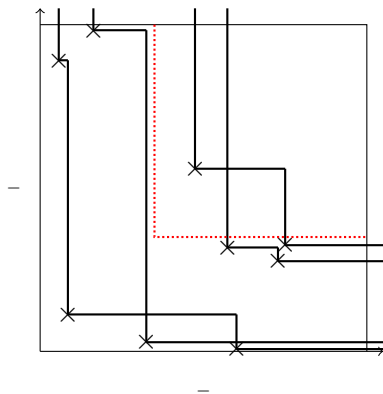

Local convergence

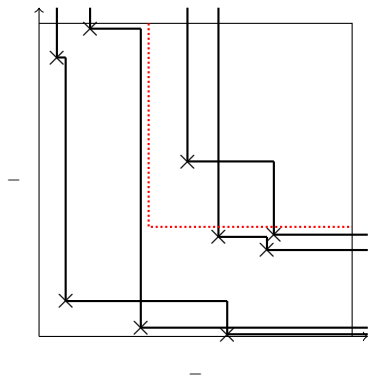

Local convergence

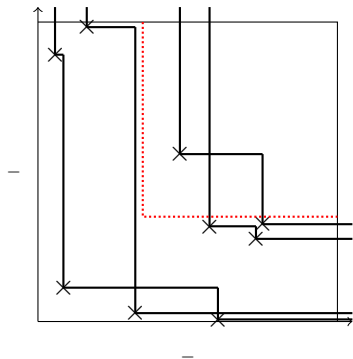

Local convergence

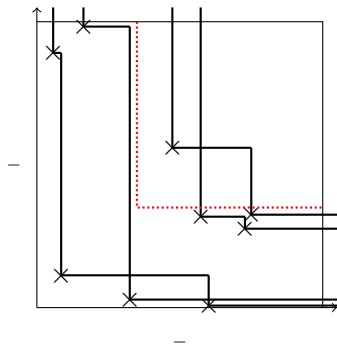

Local convergence

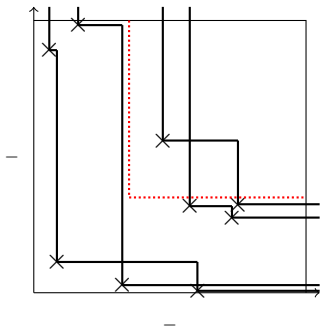

Local convergence

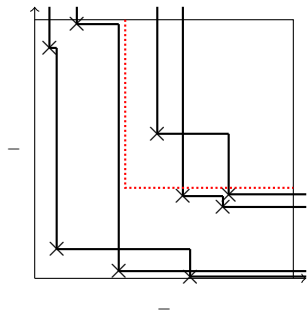

Local convergence

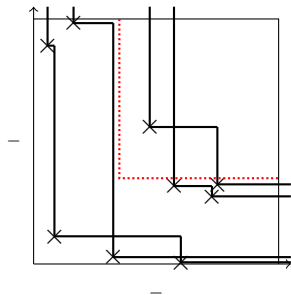

Local convergence

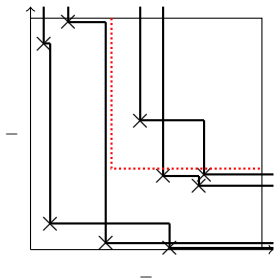

Local convergence

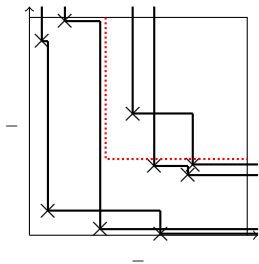

Local convergence

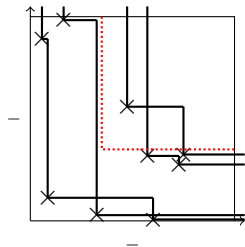

Local convergence

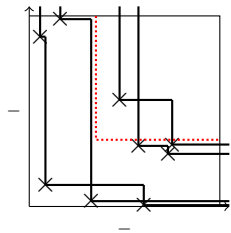

Local convergence

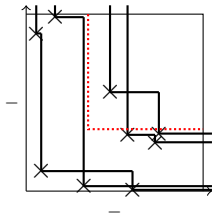

Local convergence

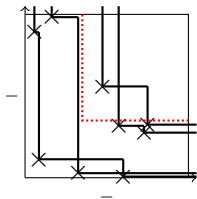

Local convergence

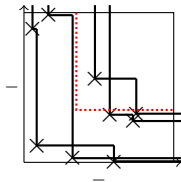

Local convergence

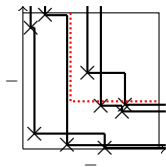

Local convergence

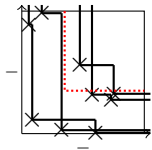

Local convergence

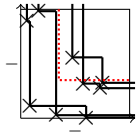

Local convergence

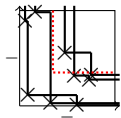

Local convergence



Local convergence

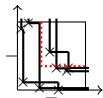

Local convergence

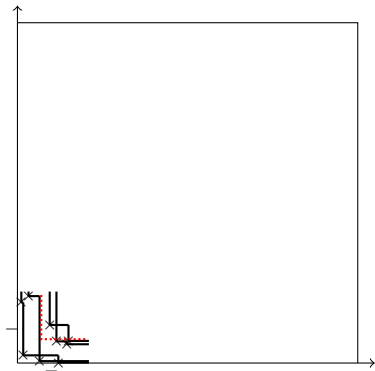

Local convergence

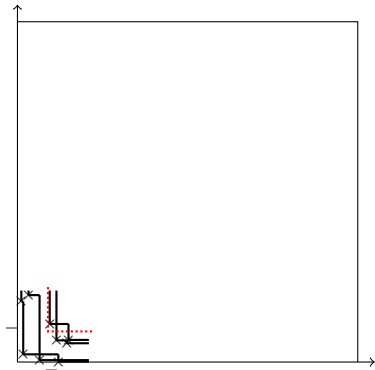

Local convergence

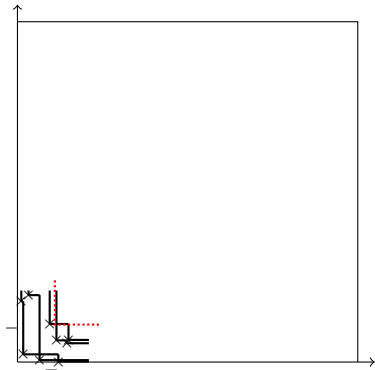

Local convergence

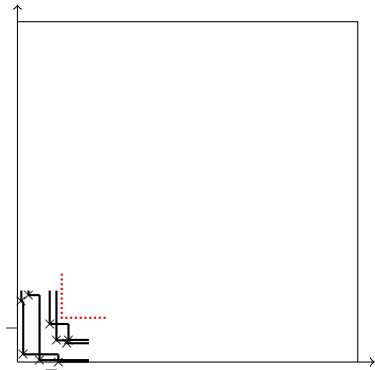

Local convergence

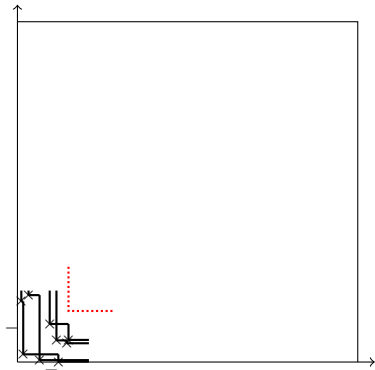

Local convergence

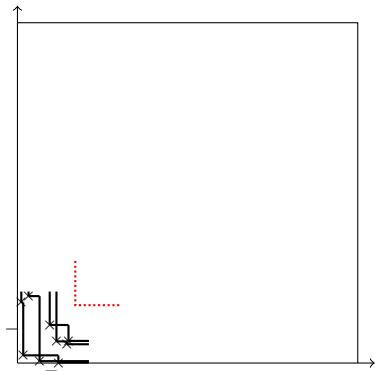

Local convergence

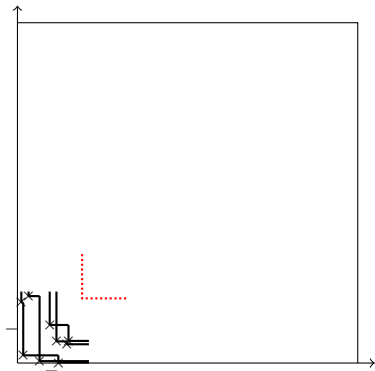

Local convergence

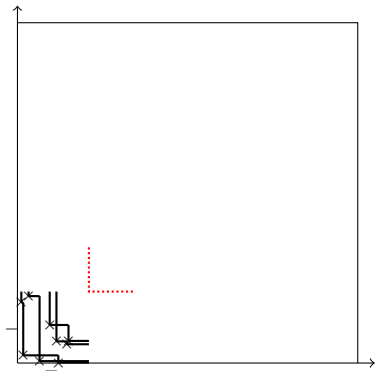

Local convergence

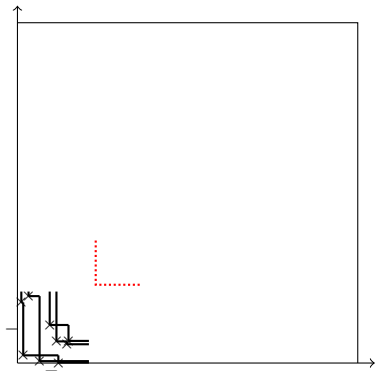

Local convergence

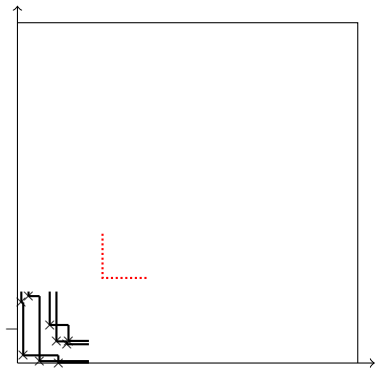

Local convergence

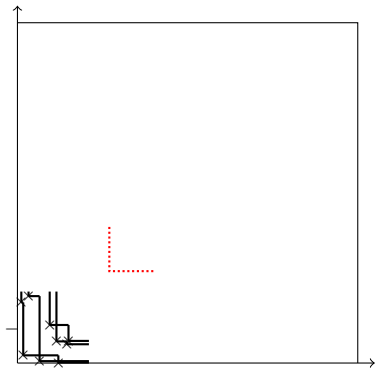

Local convergence

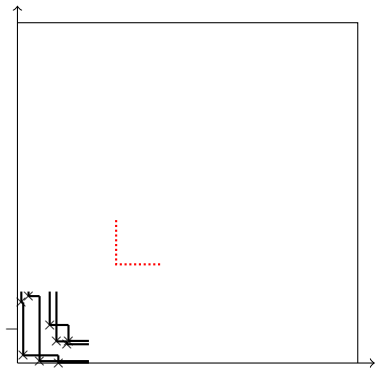

Local convergence

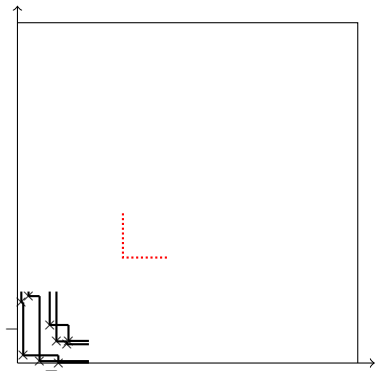

Local convergence

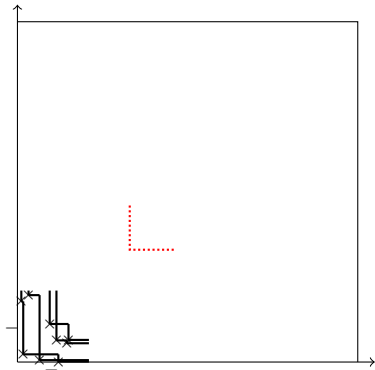

Local convergence

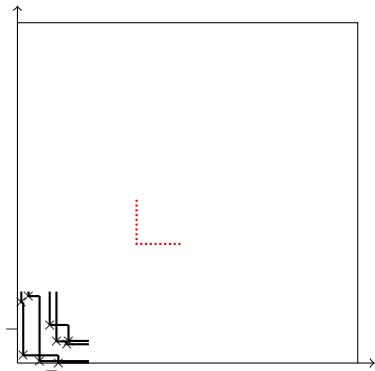

Local convergence

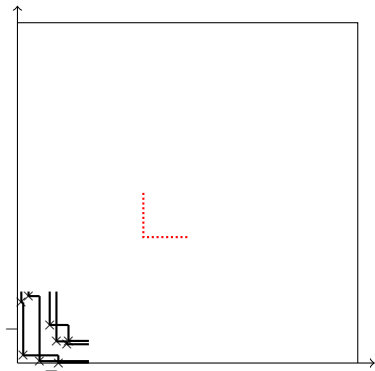

Local convergence

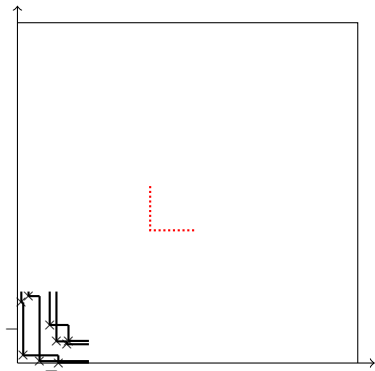

Local convergence

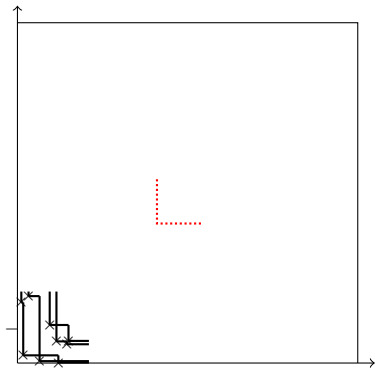

Local convergence

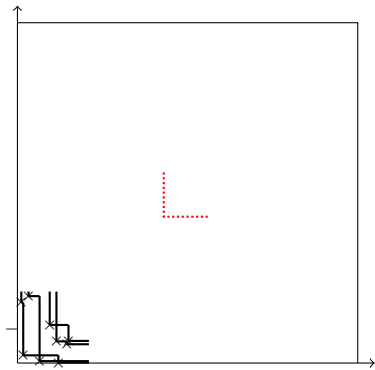

Local convergence

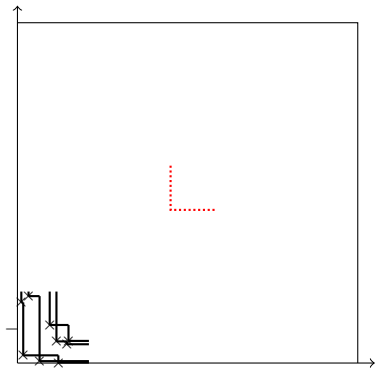

Local convergence

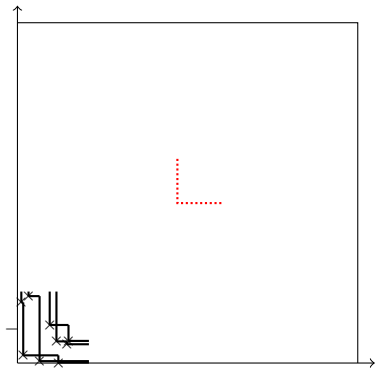

Local convergence

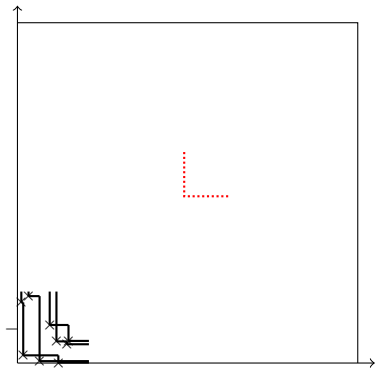

Local convergence

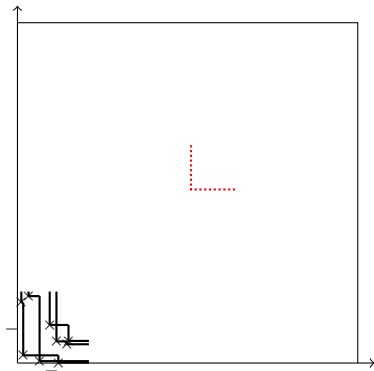

Local convergence

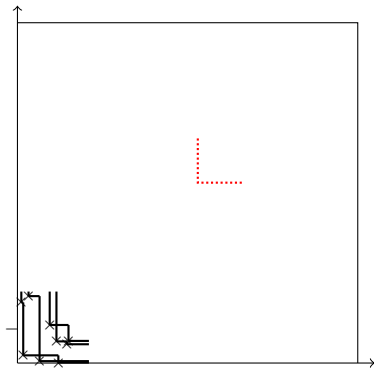

Local convergence

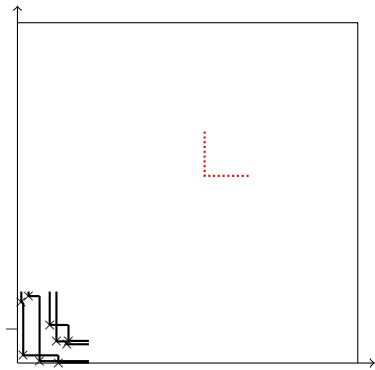

Local convergence

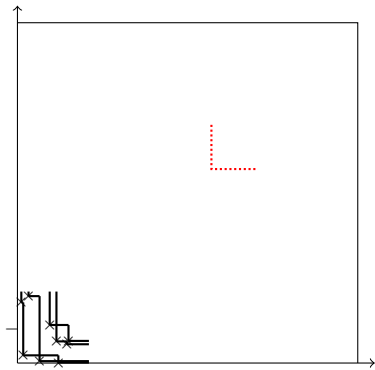

Local convergence

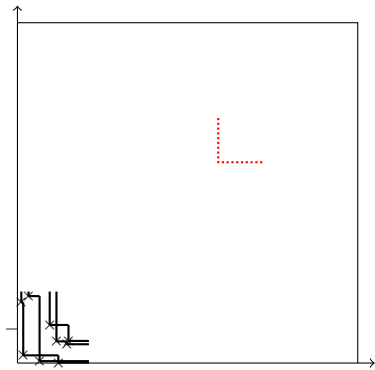

Local convergence

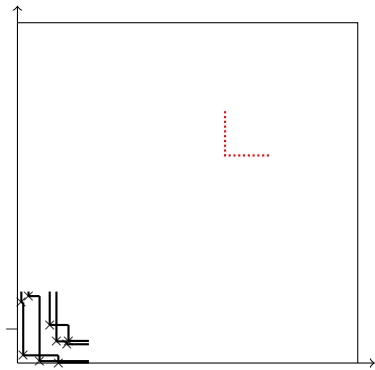

Local convergence

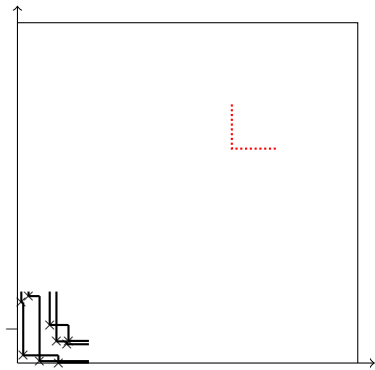

Local convergence

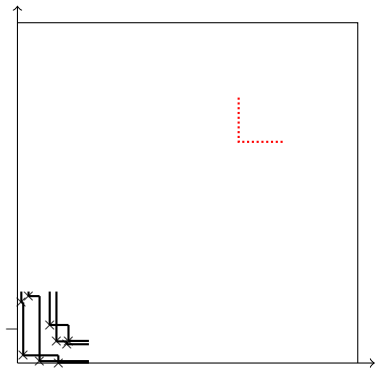

Local convergence

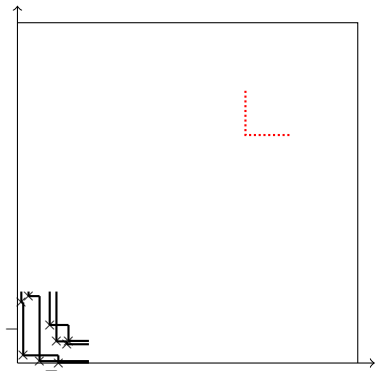

Local convergence

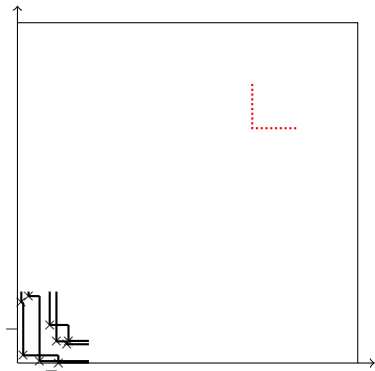

Local convergence

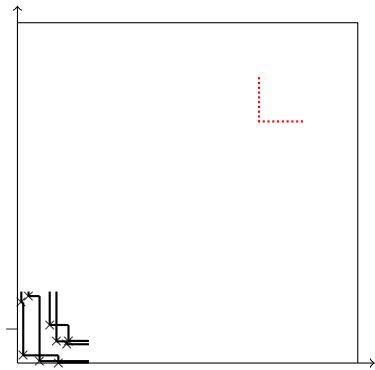

Local convergence

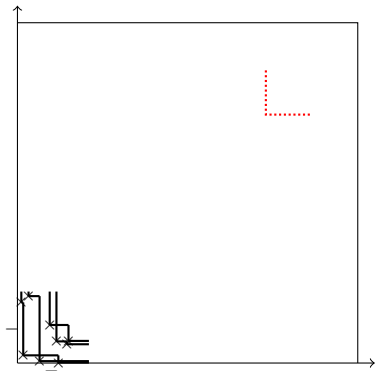

Local convergence

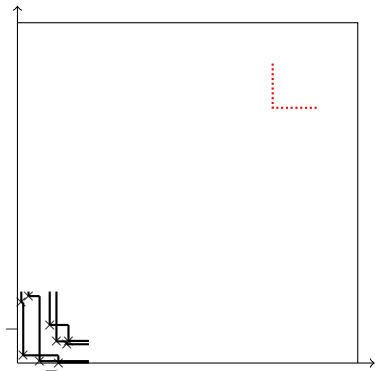

Local convergence

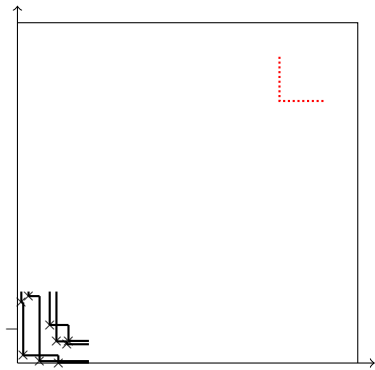

Local convergence

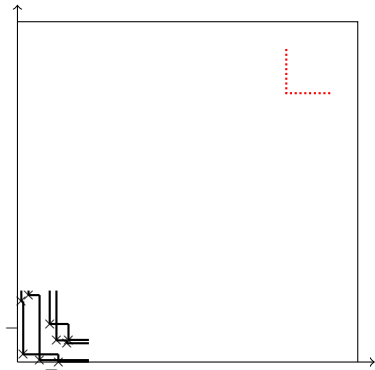

Local convergence

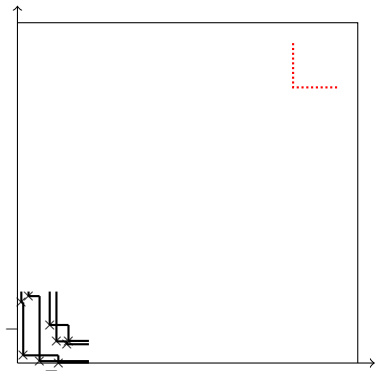

Local convergence

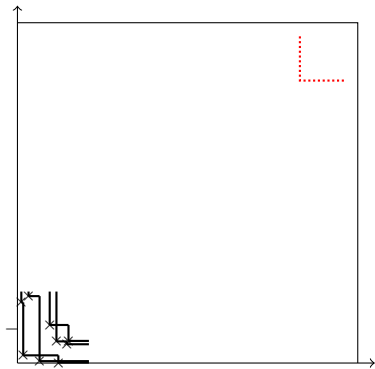

Local convergence

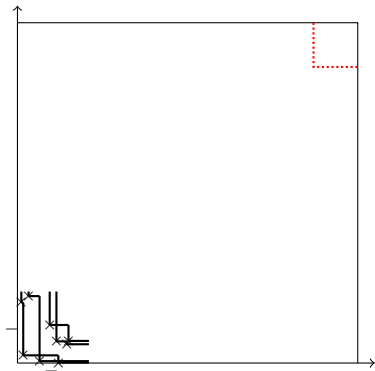

Local convergence

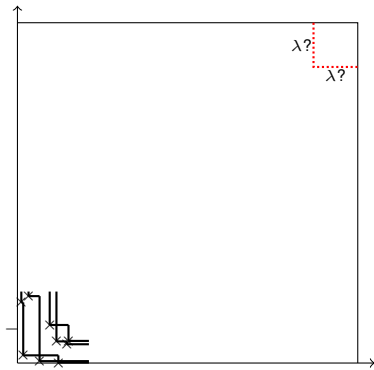

Local convergence

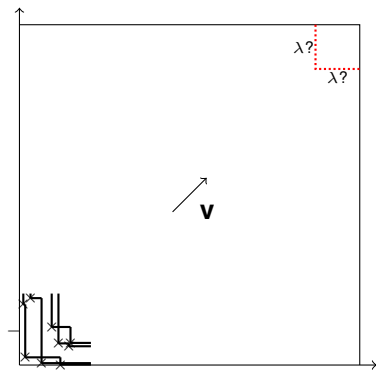

Local convergence

Theorem

*Yes, the boundaries of the small box converge in distribution to the two independent stationary Poisson processes with an explicit $\lambda = \lambda(\mathbf{v})$ (*direction*).*

Local convergence

Theorem

*Yes, the boundaries of the small box converge in distribution to the two independent stationary Poisson processes with an explicit $\lambda = \lambda(\mathbf{v})$ (*direction*).*

- ▶ Confirms the conjecture from [Drillick, Lin '24].

Local convergence

Theorem

*Yes, the boundaries of the small box converge in distribution to the two independent stationary Poisson processes with an explicit $\lambda = \lambda(\mathbf{v})$ (*direction*).*

- ▶ Confirms the conjecture from [Drillick, Lin '24].
- ▶ Hence the full t -PNG inside the small box converges to stationary t -PNG.

Local convergence

Theorem

*Yes, the boundaries of the small box converge in distribution to the two independent stationary Poisson processes with an explicit $\lambda = \lambda(\mathbf{v})$ (*direction*).*

- ▶ Confirms the conjecture from [Drillick, Lin '24].
- ▶ Hence the full t -PNG inside the small box converges to stationary t -PNG.
- ▶ The actual limit intensities are $\frac{1}{\sqrt{1-t}} \sqrt{\frac{v_2}{v_1}}$ for **sources** and $\frac{1}{\sqrt{1-t}} \sqrt{\frac{v_1}{v_2}}$ for **sinks**.

Shape theorem [Drillick, Lin '24]

Define $L_x :=$ no. of lines entering the bottom or right edge.

Then $L_x =$ no. of lines exiting the left or top edge.

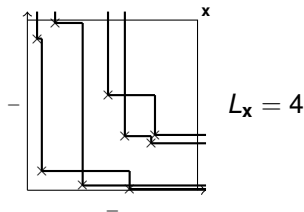

Shape theorem [Drillick, Lin '24]

Define $L_{\mathbf{x}}$:= no. of lines entering the bottom or right edge.

Then $L_{\mathbf{x}} =$ no. of lines exiting the left or top edge.

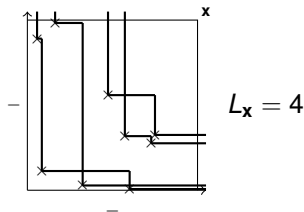

Theorem

With zero boundaries,

$$\lim_{\mathbf{x} \rightarrow \infty} \frac{L_{\mathbf{x}}}{|\mathbf{x}|} = 2 \sqrt{\frac{v_1 v_2}{|\mathbf{v}|^2 \cdot (1-t)}}.$$

Second class particles

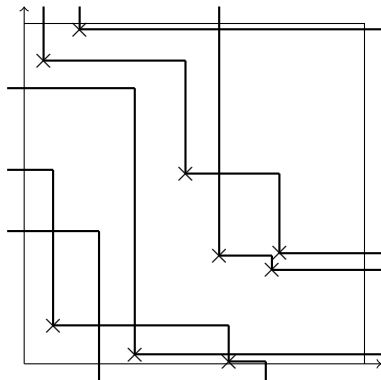
 α

Second class particles

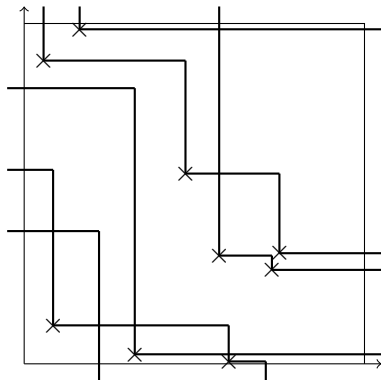

Definition: $\alpha \leq \omega$, if

- ▶ more verticals in ω ,
- ▶ more horizontals in α .

Second class particles

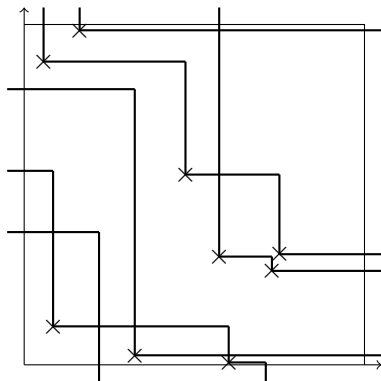

Definition: $\alpha \leq \omega$, if

- ▶ more verticals in ω ,
- ▶ more horizontals in α .
- ▶ (less horizontals in ω .)

Second class particles

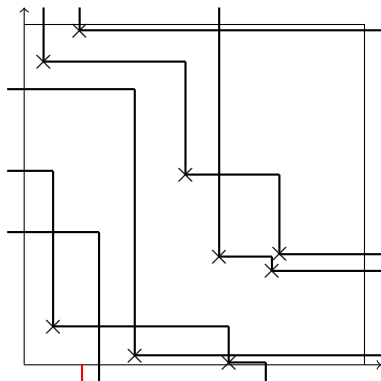

Definition: $\alpha \leq \omega$, if

- ▶ more verticals in ω ,
- ▶ more horizontals in α .
- ▶ (less horizontals in ω .)

Second class particles

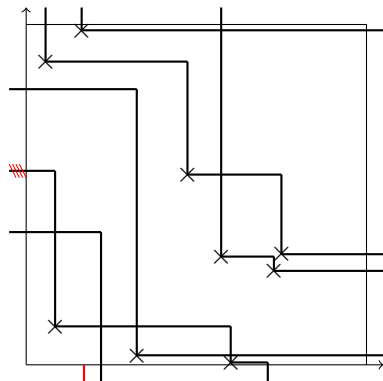

Definition: $\alpha \leq \omega$, if

- ▶ more verticals in ω ,
- ▶ more horizontals in α .
- ▶ (less horizontals in ω .)

Second class particles

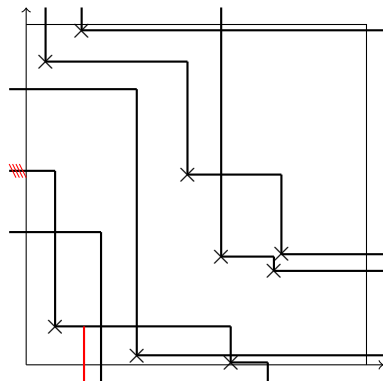

Definition: $\alpha \leq \omega$, if

- ▶ more verticals in ω ,
- ▶ more horizontals in α .
- ▶ (less horizontals in ω .)

Second class particles

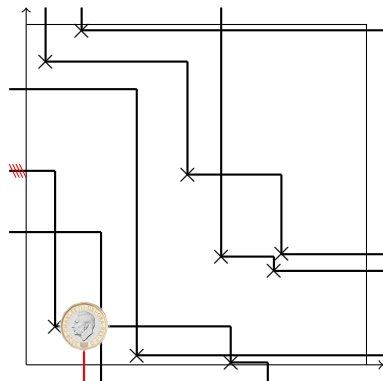

Definition: $\alpha \leq \omega$, if

- ▶ more verticals in ω ,
- ▶ more horizontals in α .
- ▶ (less horizontals in ω .)

Second class particles

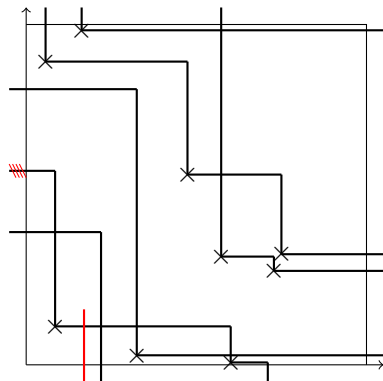

Definition: $\alpha \leq \omega$, if

- ▶ more verticals in ω ,
- ▶ more horizontals in α .
- ▶ (less horizontals in ω .)

Second class particles

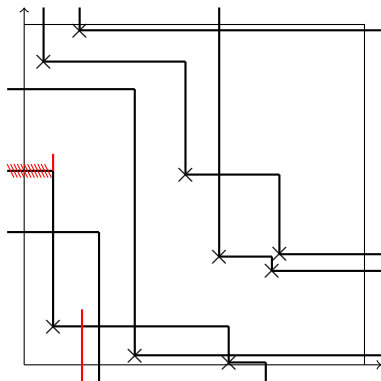

Definition: $\alpha \leq \omega$, if

- ▶ more verticals in ω ,
- ▶ more horizontals in α .
- ▶ (less horizontals in ω .)

Second class particles

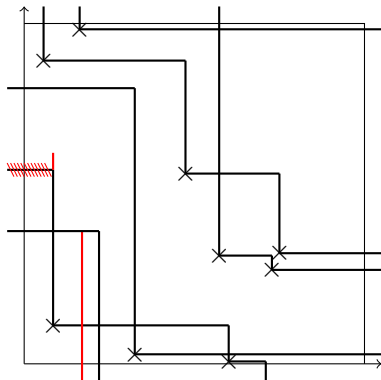

Definition: $\alpha \leq \omega$, if

- ▶ more verticals in ω ,
- ▶ more horizontals in α .
- ▶ (less horizontals in ω .)

Second class particles

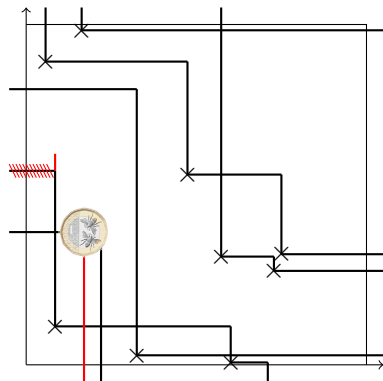

Definition: $\alpha \leq \omega$, if

- ▶ more verticals in ω ,
- ▶ more horizontals in α .
- ▶ (less horizontals in ω .)

Second class particles

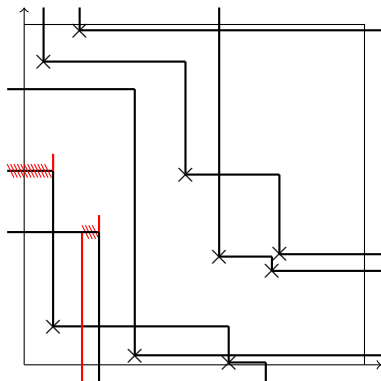

Definition: $\alpha \leq \omega$, if

- ▶ more verticals in ω ,
- ▶ more horizontals in α .
- ▶ (less horizontals in ω .)

Second class particles

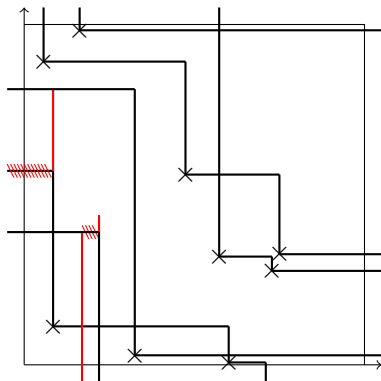

Definition: $\alpha \leq \omega$, if

- ▶ more verticals in ω ,
- ▶ more horizontals in α .
- ▶ (less horizontals in ω .)

Second class particles

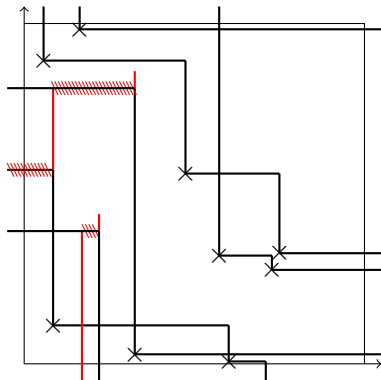

Definition: $\alpha \leq \omega$, if

- ▶ more verticals in ω ,
- ▶ more horizontals in α .
- ▶ (less horizontals in ω .)

Second class particles

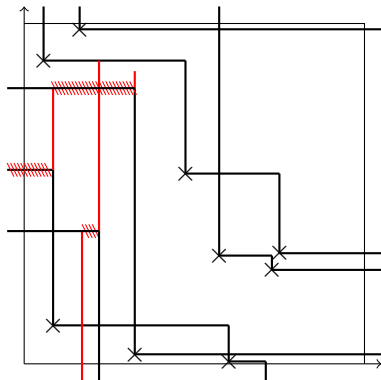

Definition: $\alpha \leq \omega$, if

- ▶ more verticals in ω ,
- ▶ more horizontals in α .
- ▶ (less horizontals in ω .)

Second class particles

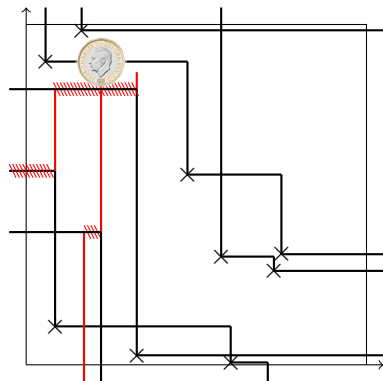

Definition: $\alpha \leq \omega$, if

- ▶ more verticals in ω ,
- ▶ more horizontals in α .
- ▶ (less horizontals in ω .)

Second class particles

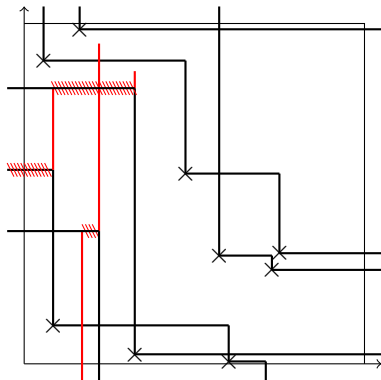

Definition: $\alpha \leq \omega$, if

- ▶ more verticals in ω ,
- ▶ more horizontals in α .
- ▶ (less horizontals in ω .)

Second class particles

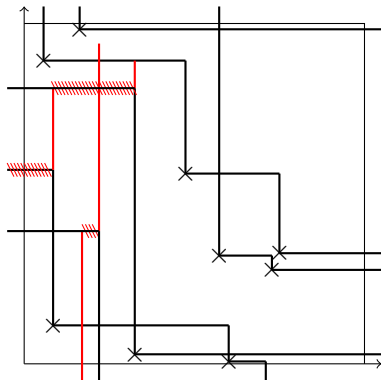

Definition: $\alpha \leq \omega$, if

- ▶ more verticals in ω ,
- ▶ more horizontals in α .
- ▶ (less horizontals in ω .)

Second class particles

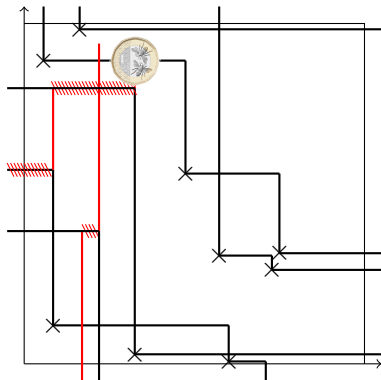

Definition: $\alpha \leq \omega$, if

- ▶ more verticals in ω ,
- ▶ more horizontals in α .
- ▶ (less horizontals in ω .)

Second class particles

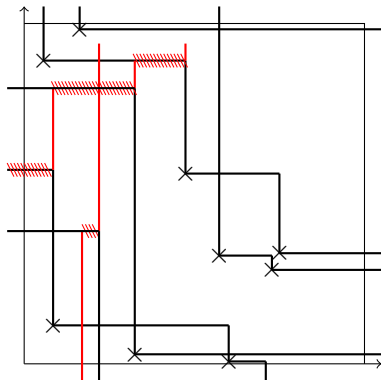

Definition: $\alpha \leq \omega$, if

- ▶ more verticals in ω ,
- ▶ more horizontals in α .
- ▶ (less horizontals in ω .)

Second class particles

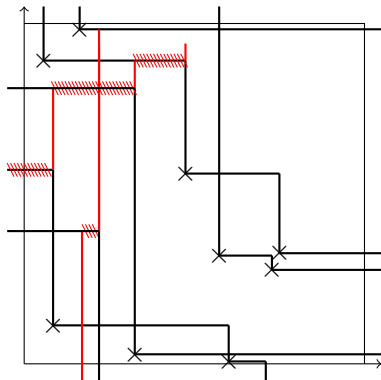

Definition: $\alpha \leq \omega$, if

- ▶ more verticals in ω ,
- ▶ more horizontals in α .
- ▶ (less horizontals in ω .)

Second class particles

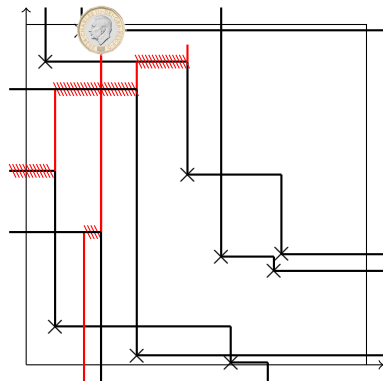

Definition: $\alpha \leq \omega$, if

- ▶ more verticals in ω ,
- ▶ more horizontals in α .
- ▶ (less horizontals in ω .)

Second class particles

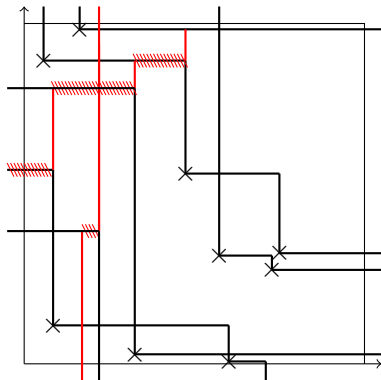

Definition: $\alpha \leq \omega$, if

- ▶ more verticals in ω ,
- ▶ more horizontals in α .
- ▶ (less horizontals in ω .)

Second class particles

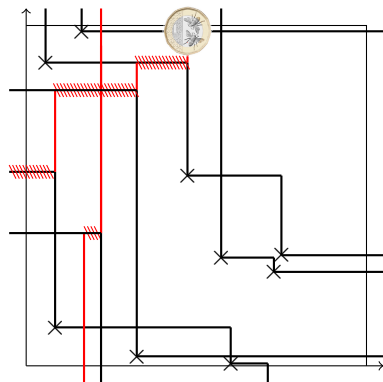

Definition: $\alpha \leq \omega$, if

- ▶ more verticals in ω ,
- ▶ more horizontals in α .
- ▶ (less horizontals in ω .)

Second class particles

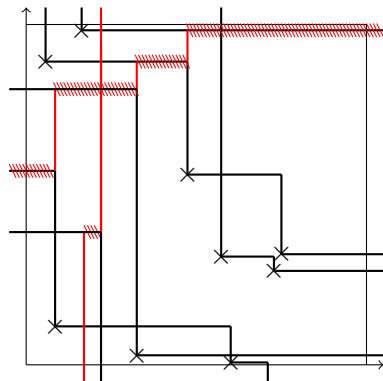

Definition: $\alpha \leq \omega$, if

- ▶ more verticals in ω ,
- ▶ more horizontals in α .
- ▶ (less horizontals in ω .)

Second class particles

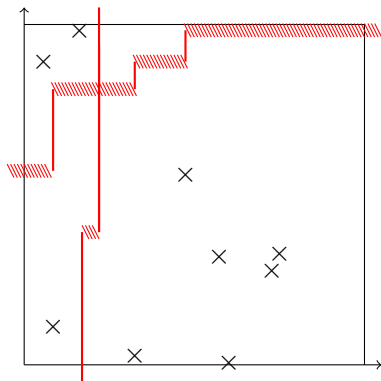

Definition: $\alpha \leq \omega$, if

- ▶ more verticals in ω ,
- ▶ more horizontals in α .
- ▶ (less horizontals in ω .)

$\frac{\alpha}{\omega}$ second class particles:
upright paths

Second class particles

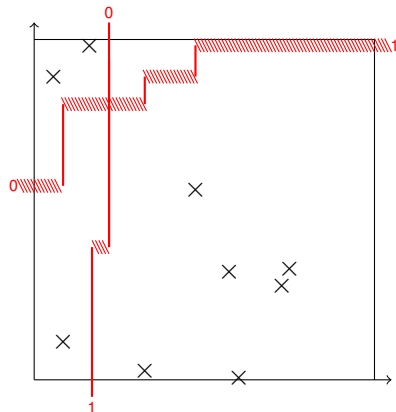

Definition: $\alpha \leq \omega$, if

- ▶ more verticals in ω ,
- ▶ more horizontals in α .
- ▶ (less horizontals in ω .)

$\frac{\alpha}{\omega}$ second class particles:
upright paths
that stay ordered

Second class particles

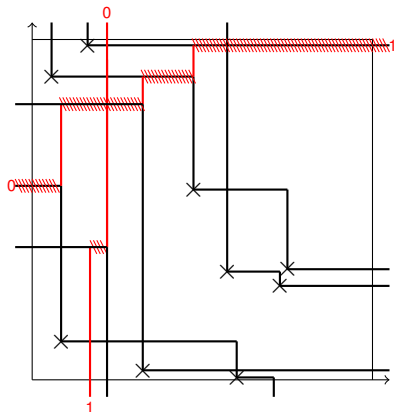

Definition: $\alpha \leq \omega$, if

- ▶ more verticals in ω ,
- ▶ more horizontals in α .
- ▶ (less horizontals in ω .)

$\frac{\omega}{\alpha}$ second class particles:
upright paths
that stay ordered

Second class particles

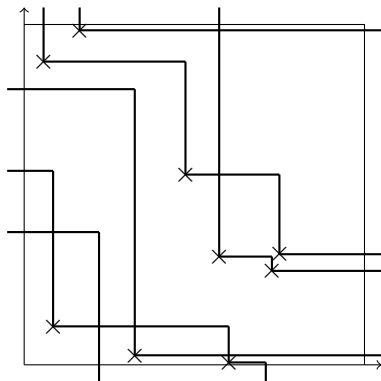

Definition: $\alpha \leq \omega$, if

- ▶ more verticals in ω ,
- ▶ more horizontals in α .
- ▶ (less horizontals in ω .)

$\frac{\omega}{\alpha}$ second class particles:
upright paths
that stay ordered

Second class particles

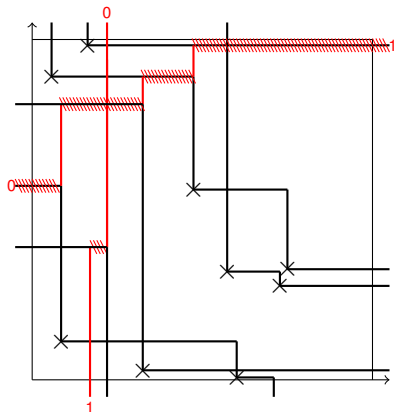

Definition: $\alpha \leq \omega$, if

- ▶ more verticals in ω ,
- ▶ more horizontals in α .
- ▶ (less horizontals in ω .)

$\frac{\omega}{\alpha}$ second class particles:
upright paths
that stay ordered

Second class particles

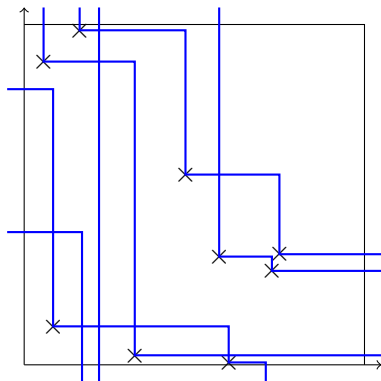

Definition: $\alpha \leq \omega$, if

- ▶ more verticals in ω ,
- ▶ more horizontals in α .
- ▶ (less horizontals in ω .)

$\frac{\omega}{\alpha}$ second class particles:
upright paths
that stay ordered

The main actors

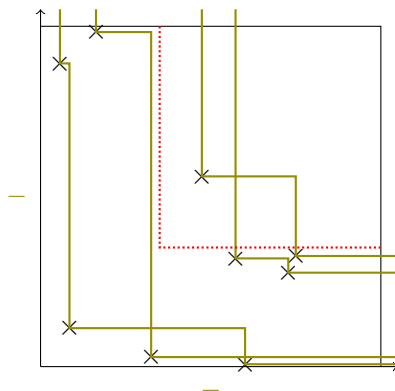

WTS: lines crossing L \rightarrow
 $\text{stati}(\lambda(\mathbf{v}))$ Poisson

$\theta^{-,-}$

The main actors

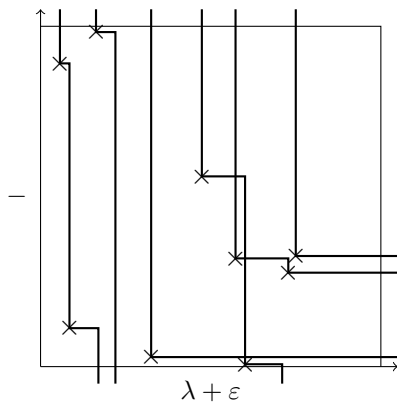

WTS: lines crossing  \rightarrow
 $\text{stati}(\lambda(\mathbf{v}))$ Poisson

$$\theta^{-,-} \leq \omega^{\lambda+\epsilon,-}$$

$$\omega^{\lambda+\epsilon,-}$$

The main actors

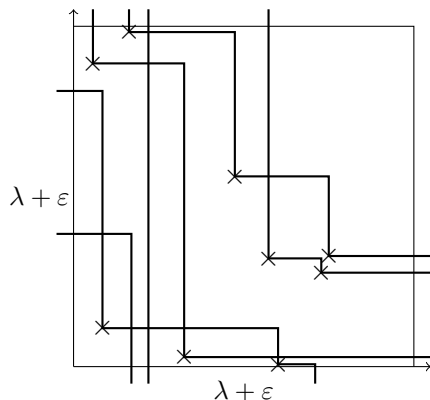

WTS: lines crossing $\begin{matrix} \text{---} \\ | \\ \text{---} \end{matrix}$ \rightarrow
 $\text{stati}(\lambda(\mathbf{v}))$ Poisson

$$\theta^{-,-} \leq \omega^{\lambda+\epsilon,-}$$

$$\omega^{\lambda+\epsilon,-} \geq \eta^{\lambda+\epsilon,\lambda+\epsilon}$$

The main actors

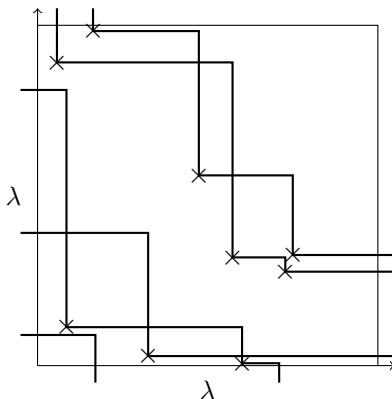

WTS: lines crossing $\begin{array}{c} \text{---} \\ | \\ \text{---} \end{array} \rightarrow$
 $\text{stati}(\lambda(\mathbf{v}))$ Poisson

$$\theta^{-,-} \leq \omega^{\lambda+\varepsilon,-}$$

$$\omega^{\lambda+\varepsilon,-} \geq \eta^{\lambda+\varepsilon,\lambda+\varepsilon} \geq \alpha^{\lambda,\lambda}$$

The main actors

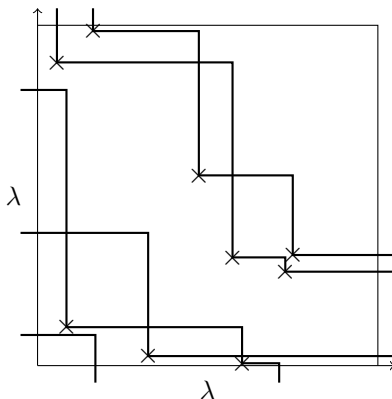

WTS: lines crossing \llcorner \rightarrow
 $\text{stati}(\lambda(\mathbf{v}))$ Poisson

$$\theta^{-,-} \leq \omega^{\lambda+\varepsilon,-}$$

$$\omega^{\lambda+\varepsilon,-} \geq \eta^{\lambda+\varepsilon,\lambda+\varepsilon} \geq \alpha^{\lambda,\lambda}$$

$$\theta^{-,-} \leq \omega^{\lambda+\varepsilon,-} \geq \eta^{\lambda+\varepsilon,\lambda+\varepsilon} \geq \alpha^{\lambda,\lambda}$$

1. $\frac{\omega^{\lambda+\varepsilon,-}}{\alpha^{\lambda,\lambda}}$ 2nd class particles and the small box

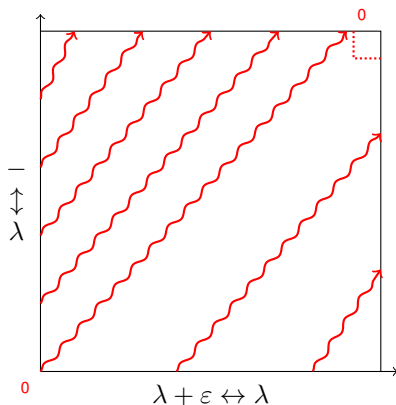

Second class particle 0 goes above the small box.

$$\theta^{-,-} \leq \underline{\omega^{\lambda+\varepsilon,-}} \geq \underline{\eta^{\lambda+\varepsilon,\lambda+\varepsilon}} \geq \underline{\alpha^{\lambda,\lambda}}$$

1. $\frac{\omega^{\lambda+\varepsilon,-}}{\alpha^{\lambda,\lambda}}$ 2nd class particles and the small box

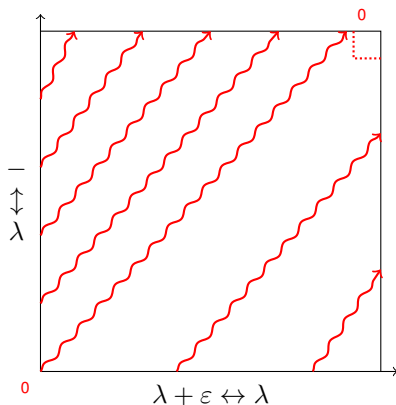

Second class particle 0 goes above the small box.

That's because of the shape thm for each $\omega^{\lambda+\varepsilon,-}$ and $\alpha^{\lambda,\lambda}$,

and the ε leeway.

$$\theta^{-,-} \leq \underline{\omega^{\lambda+\varepsilon,-}} \geq \underline{\eta^{\lambda+\varepsilon,\lambda+\varepsilon}} \geq \underline{\alpha^{\lambda,\lambda}}$$

2. $\frac{\omega^{\lambda+\varepsilon,-}}{\eta^{\lambda+\varepsilon,\lambda+\varepsilon}}$ on $\frac{\omega^{\lambda+\varepsilon,-}}{\alpha^{\lambda,\lambda}}$

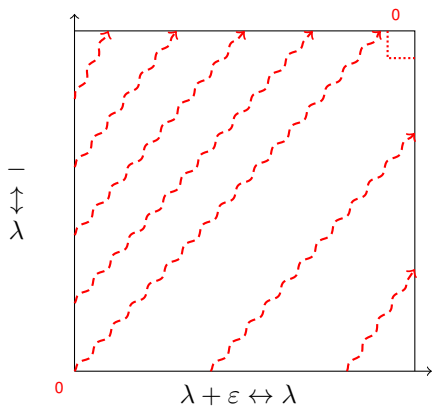

$$\theta^{-,-} \leq \underline{\omega^{\lambda+\varepsilon,-}} \geq \underline{\eta^{\lambda+\varepsilon,\lambda+\varepsilon}} \geq \underline{\alpha^{\lambda,\lambda}}$$

2. $\frac{\omega^{\lambda+\varepsilon,-}}{\eta^{\lambda+\varepsilon,\lambda+\varepsilon}}$ on $\frac{\omega^{\lambda+\varepsilon,-}}{\alpha^{\lambda,\lambda}}$

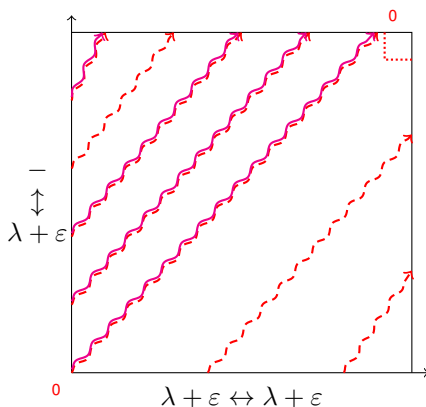

$$\left\{ \frac{\omega^{\lambda+\varepsilon,-}}{\eta^{\lambda+\varepsilon,\lambda+\varepsilon}} \right\} \subseteq \left\{ \frac{\omega^{\lambda+\varepsilon,-}}{\alpha^{\lambda,\lambda}} \right\}$$

and only start from the left boundary.

$$\theta^{-,-} \leq \underline{\omega^{\lambda+\varepsilon,-}} \geq \eta^{\lambda+\varepsilon,\lambda+\varepsilon} \geq \alpha^{\lambda,\lambda}$$

2. $\frac{\omega^{\lambda+\varepsilon,-}}{\eta^{\lambda+\varepsilon,\lambda+\varepsilon}}$ on $\frac{\omega^{\lambda+\varepsilon,-}}{\alpha^{\lambda,\lambda}}$

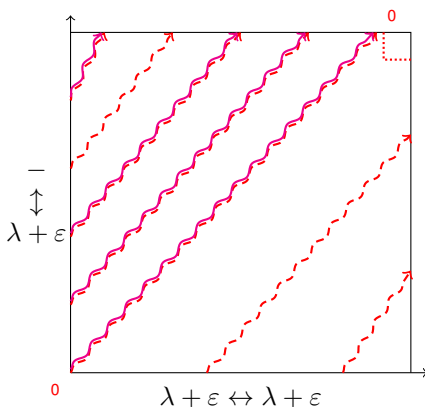

$$\left\{ \frac{\omega^{\lambda+\varepsilon,-}}{\eta^{\lambda+\varepsilon,\lambda+\varepsilon}} \right\} \subseteq \left\{ \frac{\omega^{\lambda+\varepsilon,-}}{\alpha^{\lambda,\lambda}} \right\}$$

and only start from the left boundary.

\rightsquigarrow there is a rightmost $\frac{\omega^{\lambda+\varepsilon,-}}{\eta^{\lambda+\varepsilon,\lambda+\varepsilon}}$ second class particle, jumping on $\left\{ \frac{\omega^{\lambda+\varepsilon,-}}{\alpha^{\lambda,\lambda}} \right\}$.

$$\theta^{-,-} \leq \underline{\omega^{\lambda+\varepsilon,-}} \geq \underline{\eta^{\lambda+\varepsilon,\lambda+\varepsilon}} \geq \alpha^{\lambda,\lambda}$$

3. $\frac{\omega^{\lambda+\varepsilon,-}}{\eta^{\lambda+\varepsilon,\lambda+\varepsilon}}$ on $\frac{\omega^{\lambda+\varepsilon,-}}{\alpha^{\lambda,\lambda}}$: we have drift!

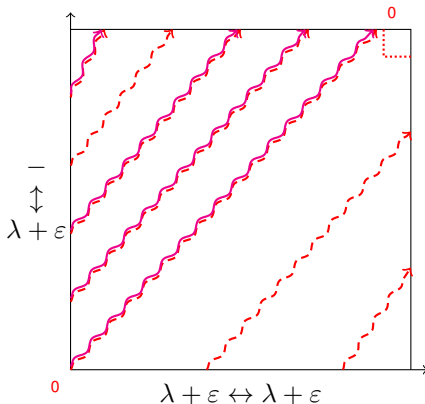

$$\left\{ \frac{\omega^{\lambda+\varepsilon,-}}{\eta^{\lambda+\varepsilon,\lambda+\varepsilon}} \right\} \subseteq \left\{ \frac{\omega^{\lambda+\varepsilon,-}}{\alpha^{\lambda,\lambda}} \right\}$$

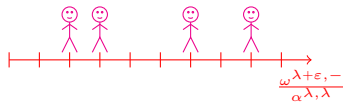

↶: prob. 1

↷: prob. t

$$\theta^{-,-} \leq \frac{\omega^{\lambda+\varepsilon,-}}{\eta^{\lambda+\varepsilon,\lambda+\varepsilon}} \geq \alpha^{\lambda,\lambda}$$

3. $\frac{\omega^{\lambda+\varepsilon,-}}{\eta^{\lambda+\varepsilon,\lambda+\varepsilon}}$ on $\frac{\omega^{\lambda+\varepsilon,-}}{\alpha^{\lambda,\lambda}}$: we have drift!

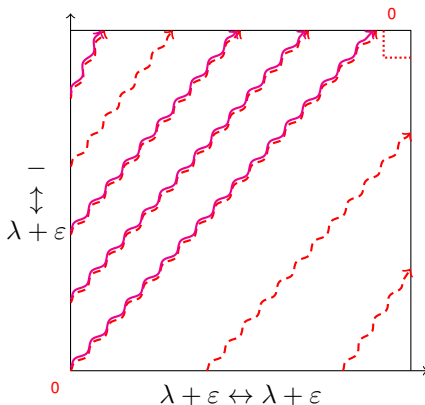

$$\left\{ \frac{\omega^{\lambda+\varepsilon,-}}{\eta^{\lambda+\varepsilon,\lambda+\varepsilon}} \right\} \subseteq \left\{ \frac{\omega^{\lambda+\varepsilon,-}}{\alpha^{\lambda,\lambda}} \right\}$$

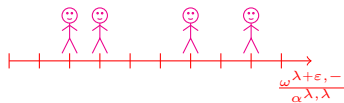

↪: prob. 1

↪: prob. t

↪ rightmost $\frac{\omega^{\lambda+\varepsilon,-}}{\eta^{\lambda+\varepsilon,\lambda+\varepsilon}}$ second class still left of the small box whp.

$$\theta^{-,-} \leq \frac{\omega^{\lambda+\varepsilon,-}}{\eta^{\lambda+\varepsilon,\lambda+\varepsilon}} \geq \alpha^{\lambda,\lambda}$$

3. $\frac{\omega^{\lambda+\varepsilon,-}}{\eta^{\lambda+\varepsilon,\lambda+\varepsilon}}$ on $\frac{\omega^{\lambda+\varepsilon,-}}{\alpha^{\lambda,\lambda}}$: we have drift!

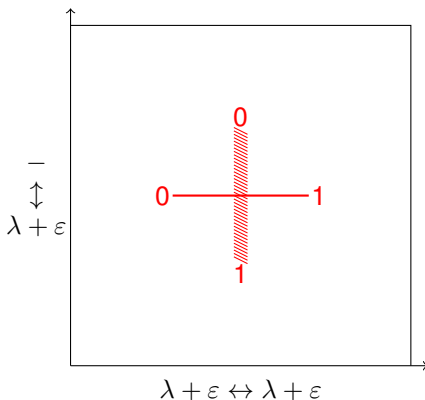

$$\left\{ \frac{\omega^{\lambda+\varepsilon,-}}{\eta^{\lambda+\varepsilon,\lambda+\varepsilon}} \right\} \subseteq \left\{ \frac{\omega^{\lambda+\varepsilon,-}}{\alpha^{\lambda,\lambda}} \right\}$$

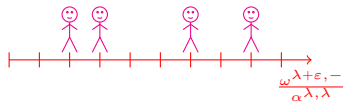

↶: prob. 1

↷: prob. t

↷ rightmost $\frac{\omega^{\lambda+\varepsilon,-}}{\eta^{\lambda+\varepsilon,\lambda+\varepsilon}}$ second class still left of the small box whp.

$$\theta^{-,-} \leq \frac{\omega^{\lambda+\varepsilon,-}}{\eta^{\lambda+\varepsilon,\lambda+\varepsilon}} \geq \alpha^{\lambda,\lambda}$$

3. $\frac{\omega^{\lambda+\varepsilon,-}}{\eta^{\lambda+\varepsilon,\lambda+\varepsilon}}$ on $\frac{\omega^{\lambda+\varepsilon,-}}{\alpha^{\lambda,\lambda}}$: we have drift!

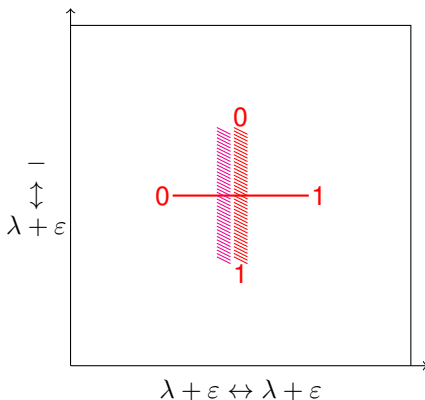

$$\left\{ \frac{\omega^{\lambda+\varepsilon,-}}{\eta^{\lambda+\varepsilon,\lambda+\varepsilon}} \right\} \subseteq \left\{ \frac{\omega^{\lambda+\varepsilon,-}}{\alpha^{\lambda,\lambda}} \right\}$$

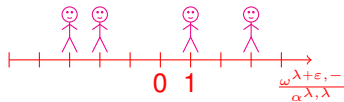

↶: prob. 1

↷: prob. t

↷ rightmost $\frac{\omega^{\lambda+\varepsilon,-}}{\eta^{\lambda+\varepsilon,\lambda+\varepsilon}}$ second class still left of the small box whp.

$$\theta^{-,-} \leq \frac{\omega^{\lambda+\varepsilon,-}}{\eta^{\lambda+\varepsilon,\lambda+\varepsilon}} \geq \alpha^{\lambda,\lambda}$$

3. $\frac{\omega^{\lambda+\varepsilon,-}}{\eta^{\lambda+\varepsilon,\lambda+\varepsilon}}$ on $\frac{\omega^{\lambda+\varepsilon,-}}{\alpha^{\lambda,\lambda}}$: we have drift!

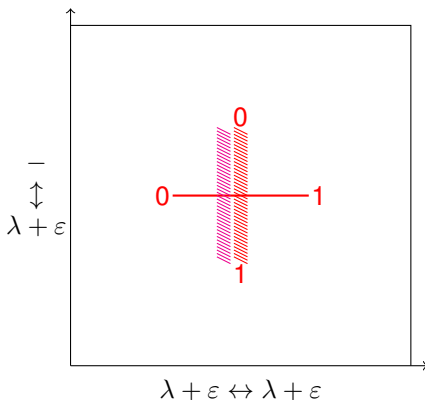

$$\left\{ \frac{\omega^{\lambda+\varepsilon,-}}{\eta^{\lambda+\varepsilon,\lambda+\varepsilon}} \right\} \subseteq \left\{ \frac{\omega^{\lambda+\varepsilon,-}}{\alpha^{\lambda,\lambda}} \right\}$$

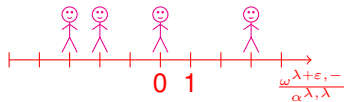

↶: prob. 1

↷: prob. t

↷ rightmost $\frac{\omega^{\lambda+\varepsilon,-}}{\eta^{\lambda+\varepsilon,\lambda+\varepsilon}}$ second class still left of the small box whp.

$$\theta^{-,-} \leq \frac{\omega^{\lambda+\varepsilon,-}}{\eta^{\lambda+\varepsilon,\lambda+\varepsilon}} \geq \alpha^{\lambda,\lambda}$$

3. $\frac{\omega^{\lambda+\varepsilon,-}}{\eta^{\lambda+\varepsilon,\lambda+\varepsilon}}$ on $\frac{\omega^{\lambda+\varepsilon,-}}{\alpha^{\lambda,\lambda}}$: we have drift!

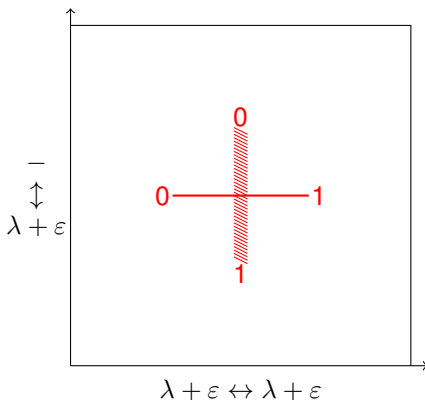

$$\left\{ \frac{\omega^{\lambda+\varepsilon,-}}{\eta^{\lambda+\varepsilon,\lambda+\varepsilon}} \right\} \subseteq \left\{ \frac{\omega^{\lambda+\varepsilon,-}}{\alpha^{\lambda,\lambda}} \right\}$$



↶: prob. 1

↷: prob. t

↷ rightmost $\frac{\omega^{\lambda+\varepsilon,-}}{\eta^{\lambda+\varepsilon,\lambda+\varepsilon}}$ second class still left of the small box whp.

$$\theta^{-,-} \leq \frac{\omega^{\lambda+\varepsilon,-}}{\eta^{\lambda+\varepsilon,\lambda+\varepsilon}} \geq \alpha^{\lambda,\lambda}$$

3. $\frac{\omega^{\lambda+\varepsilon,-}}{\eta^{\lambda+\varepsilon,\lambda+\varepsilon}}$ on $\frac{\omega^{\lambda+\varepsilon,-}}{\alpha^{\lambda,\lambda}}$: we have drift!

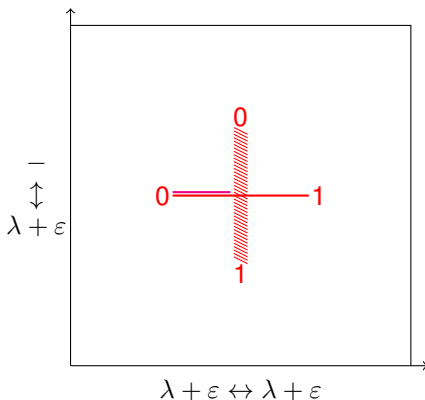

$$\left\{ \frac{\omega^{\lambda+\varepsilon,-}}{\eta^{\lambda+\varepsilon,\lambda+\varepsilon}} \right\} \subseteq \left\{ \frac{\omega^{\lambda+\varepsilon,-}}{\alpha^{\lambda,\lambda}} \right\}$$

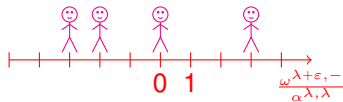

↶: prob. 1

↷: prob. t

↷ rightmost $\frac{\omega^{\lambda+\varepsilon,-}}{\eta^{\lambda+\varepsilon,\lambda+\varepsilon}}$ second class still left of the small box whp.

$$\theta^{-,-} \leq \frac{\omega^{\lambda+\varepsilon,-}}{\eta^{\lambda+\varepsilon,\lambda+\varepsilon}} \geq \alpha^{\lambda,\lambda}$$

3. $\frac{\omega^{\lambda+\varepsilon,-}}{\eta^{\lambda+\varepsilon,\lambda+\varepsilon}}$ on $\frac{\omega^{\lambda+\varepsilon,-}}{\alpha^{\lambda,\lambda}}$: we have drift!

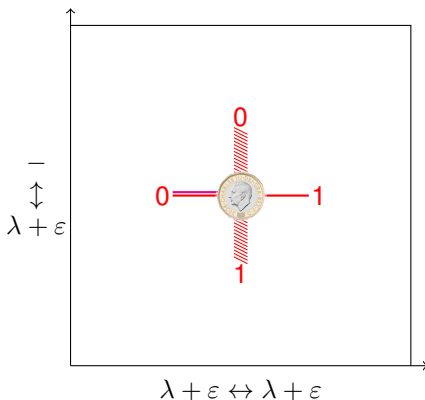

$$\left\{ \frac{\omega^{\lambda+\varepsilon,-}}{\eta^{\lambda+\varepsilon,\lambda+\varepsilon}} \right\} \subseteq \left\{ \frac{\omega^{\lambda+\varepsilon,-}}{\alpha^{\lambda,\lambda}} \right\}$$

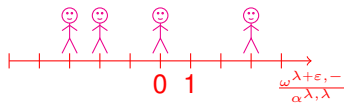

↶: prob. 1

↷: prob. t

↷ rightmost $\frac{\omega^{\lambda+\varepsilon,-}}{\eta^{\lambda+\varepsilon,\lambda+\varepsilon}}$ second class still left of the small box whp.

$$\theta^{-,-} \leq \frac{\omega^{\lambda+\varepsilon,-}}{\eta^{\lambda+\varepsilon,\lambda+\varepsilon}} \geq \alpha^{\lambda,\lambda}$$

3. $\frac{\omega^{\lambda+\varepsilon,-}}{\eta^{\lambda+\varepsilon,\lambda+\varepsilon}}$ on $\frac{\omega^{\lambda+\varepsilon,-}}{\alpha^{\lambda,\lambda}}$: we have drift!

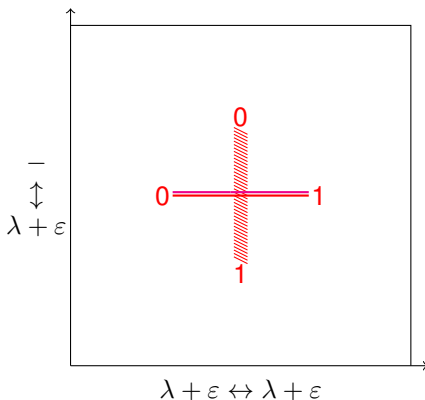

$$\left\{ \frac{\omega^{\lambda+\varepsilon,-}}{\eta^{\lambda+\varepsilon,\lambda+\varepsilon}} \right\} \subseteq \left\{ \frac{\omega^{\lambda+\varepsilon,-}}{\alpha^{\lambda,\lambda}} \right\}$$

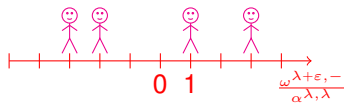

\curvearrowright : prob. 1

\curvearrowright : prob. t

\rightsquigarrow rightmost $\frac{\omega^{\lambda+\varepsilon,-}}{\eta^{\lambda+\varepsilon,\lambda+\varepsilon}}$ second class still left of the small box whp.

$$\theta^{-,-} \leq \frac{\omega^{\lambda+\varepsilon,-}}{\eta^{\lambda+\varepsilon,\lambda+\varepsilon}} \geq \alpha^{\lambda,\lambda}$$

3. $\frac{\omega^{\lambda+\varepsilon,-}}{\eta^{\lambda+\varepsilon,\lambda+\varepsilon}}$ on $\frac{\omega^{\lambda+\varepsilon,-}}{\alpha^{\lambda,\lambda}}$: we have drift!

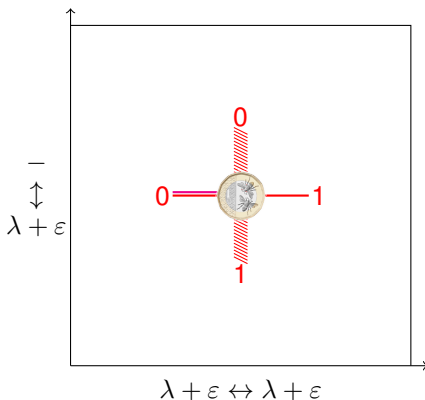

$$\left\{ \frac{\omega^{\lambda+\varepsilon,-}}{\eta^{\lambda+\varepsilon,\lambda+\varepsilon}} \right\} \subseteq \left\{ \frac{\omega^{\lambda+\varepsilon,-}}{\alpha^{\lambda,\lambda}} \right\}$$

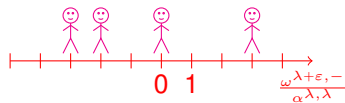

\curvearrowright : prob. 1

\curvearrowleft : prob. t

\rightsquigarrow rightmost $\frac{\omega^{\lambda+\varepsilon,-}}{\eta^{\lambda+\varepsilon,\lambda+\varepsilon}}$ second class still left of the small box whp.

$$\theta^{-,-} \leq \frac{\omega^{\lambda+\varepsilon,-}}{\eta^{\lambda+\varepsilon,\lambda+\varepsilon}} \geq \alpha^{\lambda,\lambda}$$

3. $\frac{\omega^{\lambda+\varepsilon,-}}{\eta^{\lambda+\varepsilon,\lambda+\varepsilon}}$ on $\frac{\omega^{\lambda+\varepsilon,-}}{\alpha^{\lambda,\lambda}}$: we have drift!

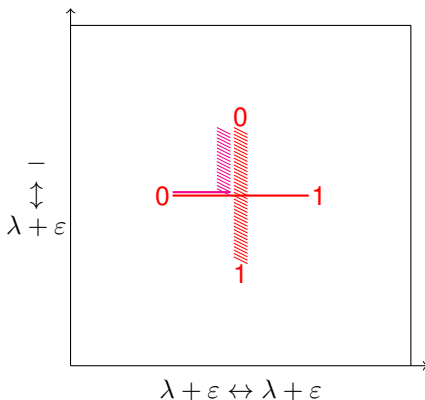

$$\left\{ \frac{\omega^{\lambda+\varepsilon,-}}{\eta^{\lambda+\varepsilon,\lambda+\varepsilon}} \right\} \subseteq \left\{ \frac{\omega^{\lambda+\varepsilon,-}}{\alpha^{\lambda,\lambda}} \right\}$$

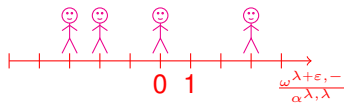

↶: prob. 1

↷: prob. t

↷ rightmost $\frac{\omega^{\lambda+\varepsilon,-}}{\eta^{\lambda+\varepsilon,\lambda+\varepsilon}}$ second class still left of the small box whp.

$$\theta^{-,-} \leq \frac{\omega^{\lambda+\varepsilon,-}}{\eta^{\lambda+\varepsilon,\lambda+\varepsilon}} \geq \alpha^{\lambda,\lambda}$$

4. Conclusion

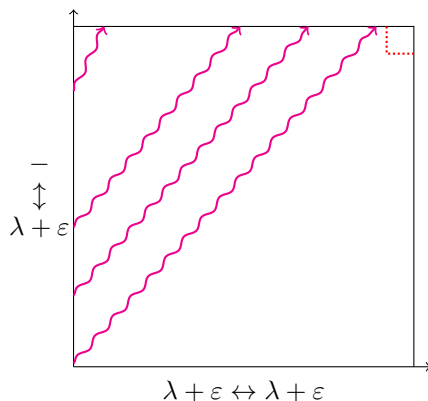

Rightmost $\frac{\omega^{\lambda+\varepsilon,-}}{\eta^{\lambda+\varepsilon,\lambda+\varepsilon}}$ second class still left of the small box whp.

$$\theta^{-,-} \leq \underline{\omega^{\lambda+\varepsilon,-}} \geq \underline{\eta^{\lambda+\varepsilon,\lambda+\varepsilon}} \geq \alpha^{\lambda,\lambda}$$

4. Conclusion

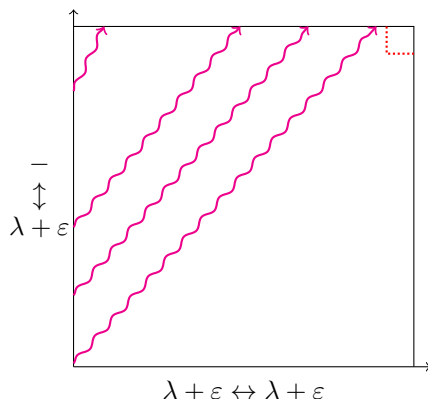

Rightmost $\frac{\omega^{\lambda+\varepsilon,-}}{\eta^{\lambda+\varepsilon,\lambda+\varepsilon}}$ second class still left of the small box whp.

$\rightsquigarrow \omega^{\lambda+\varepsilon,-} = \eta^{\lambda+\varepsilon,\lambda+\varepsilon}$ in the small box whp.

$$\theta^{-,-} \leq \underline{\omega^{\lambda+\varepsilon,-}} \geq \underline{\eta^{\lambda+\varepsilon,\lambda+\varepsilon}} \geq \alpha^{\lambda,\lambda}$$

4. Conclusion

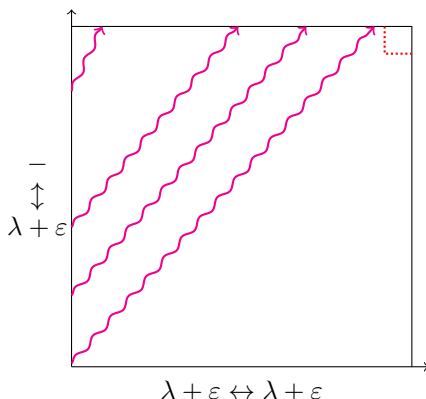

Rightmost $\frac{\omega^{\lambda+\varepsilon,-}}{\eta^{\lambda+\varepsilon,\lambda+\varepsilon}}$ second class still left of the small box whp.

$\rightsquigarrow \omega^{\lambda+\varepsilon,-} = \eta^{\lambda+\varepsilon,\lambda+\varepsilon}$ in the small box whp.

\rightsquigarrow but $\eta^{\lambda+\varepsilon,\lambda+\varepsilon}$ is stationary so has $\text{Poi}(\lambda + \varepsilon)$ lines entering the box whp.

$$\theta^{-,-} \leq \underline{\omega^{\lambda+\varepsilon,-}} \geq \underline{\eta^{\lambda+\varepsilon,\lambda+\varepsilon}} \geq \alpha^{\lambda,\lambda}$$

4. Conclusion

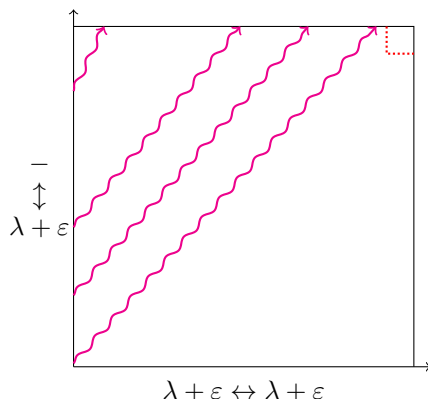

Rightmost $\frac{\omega^{\lambda+\varepsilon,-}}{\eta^{\lambda+\varepsilon,\lambda+\varepsilon}}$ second class still left of the small box whp.

$\rightsquigarrow \omega^{\lambda+\varepsilon,-} = \eta^{\lambda+\varepsilon,\lambda+\varepsilon}$ in the small box whp.

\rightsquigarrow but $\eta^{\lambda+\varepsilon,\lambda+\varepsilon}$ is stationary so has $\text{Poi}(\lambda + \varepsilon)$ lines entering the box whp.

\rightsquigarrow whp. $\theta^{-,-} \leq \text{Poi}(\lambda + \varepsilon)$
 $\forall \varepsilon > 0$.

$$\theta^{-,-} \leq \underline{\omega^{\lambda+\varepsilon,-}} \geq \underline{\eta^{\lambda+\varepsilon,\lambda+\varepsilon}} \geq \alpha^{\lambda,\lambda}$$

4. Conclusion

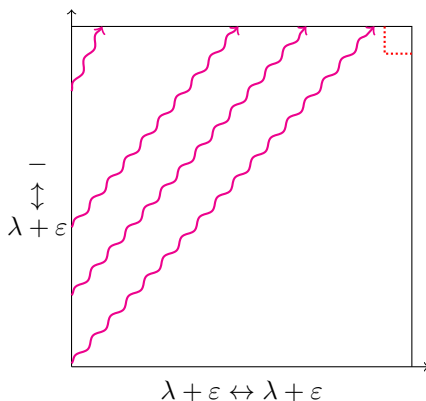

Thank you.

Rightmost $\frac{\omega^{\lambda+\varepsilon,-}}{\eta^{\lambda+\varepsilon,\lambda+\varepsilon}}$ second class still left of the small box whp.

$\rightsquigarrow \omega^{\lambda+\varepsilon,-} = \eta^{\lambda+\varepsilon,\lambda+\varepsilon}$ in the small box whp.

\rightsquigarrow but $\eta^{\lambda+\varepsilon,\lambda+\varepsilon}$ is stationary so has $\text{Poi}(\lambda + \varepsilon)$ lines entering the box whp.

\rightsquigarrow whp. $\theta^{-,-} \leq \text{Poi}(\lambda + \varepsilon)$
 $\forall \varepsilon > 0.$

$$\theta^{-,-} \leq \underline{\omega^{\lambda+\varepsilon,-}} \geq \underline{\eta^{\lambda+\varepsilon,\lambda+\varepsilon}} \geq \alpha^{\lambda,\lambda}$$