

Queues, stationarity, and stabilisation of last passage percolation

Joint with
Ofar Busani and Timo Seppäläinen

Márton Balázs

University of Bristol

Warwick, 23 February, 2023.

Last passage percolation

- ▶ Place ω_z i.i.d. $\text{Exp}(1)$ for $z \in \mathbb{Z}^2$.
- ▶ The *geodesic* $\pi_{a,y}$ from a to y is the a.s. unique heaviest up-right path from a to y . Its weight is $G_{a,y}$.

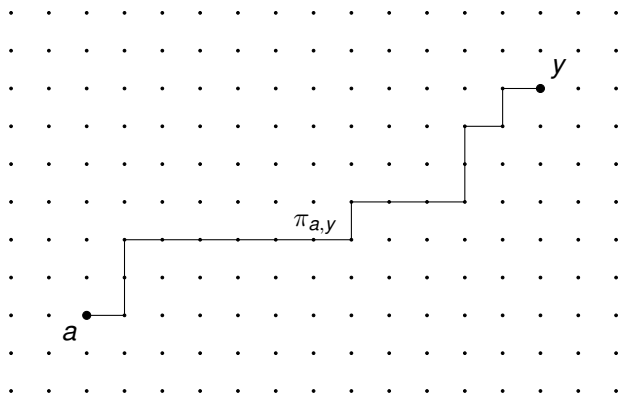

$G_{0,y}$ is the time TASEP hole y_1 swaps with particle y_2 if started from 1-0 initial condition.

Coalescing: OK

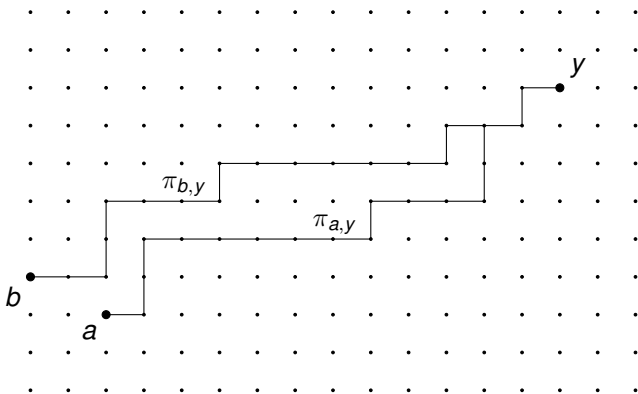

But loops: not OK

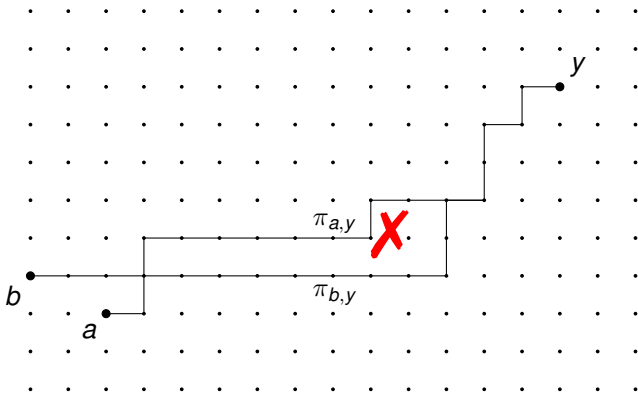

Increments as new boundary

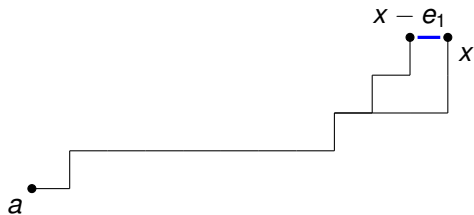

$$I_x = G_{a,x} - G_{a,x-e_1}$$

Increments as new boundary

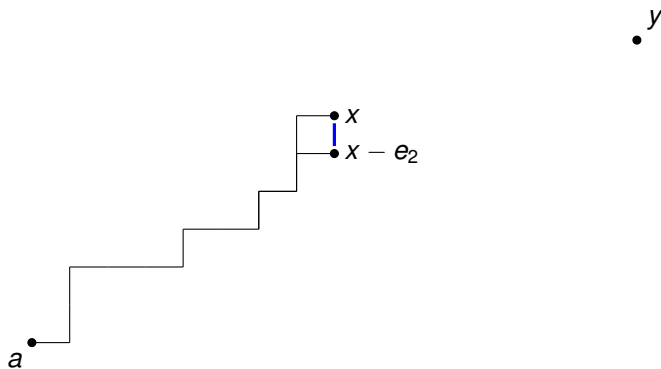

$$I_x = G_{a,x} - G_{a,x-e_1}$$

$$J_x = G_{a,x} - G_{a,x-e_2}$$

Increments as new boundary

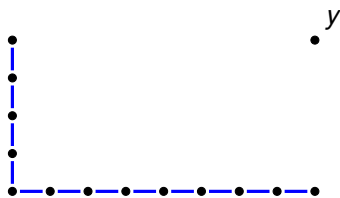

a

$$I_x = G_{a,x} - G_{a,x-e_1}$$

$$J_x = G_{a,x} - G_{a,x-e_2}$$

Increments as new boundary

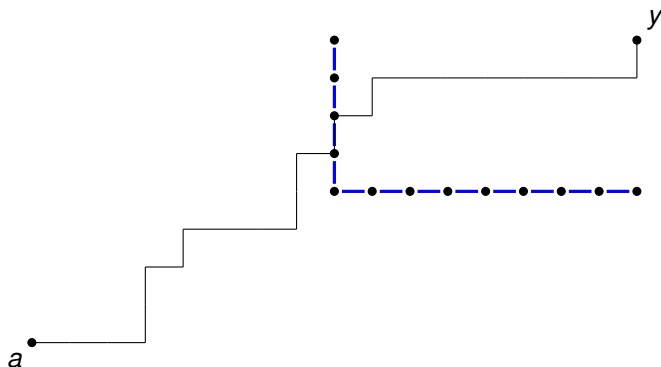

$$I_x = G_{a,x} - G_{a,x-e_1}$$

$$J_x = G_{a,x} - G_{a,x-e_2}$$

Increments as new boundary

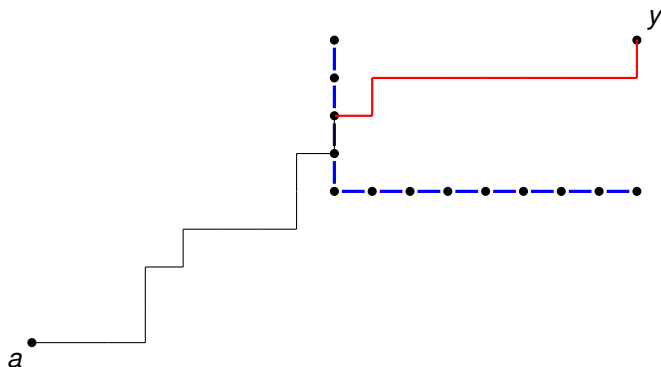

$$I_x = G_{a,x} - G_{a,x-e_1}$$

$$J_x = G_{a,x} - G_{a,x-e_2}$$

Increments as new boundary

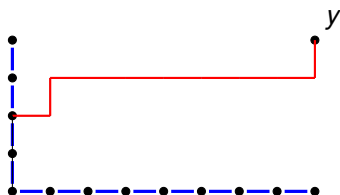

a

$$I_x = G_{a,x} - G_{a,x-e_1} \quad J_x = G_{a,x} - G_{a,x-e_2}$$

↪ Act as boundary weights for a smaller, embedded model.

Stationary LPP

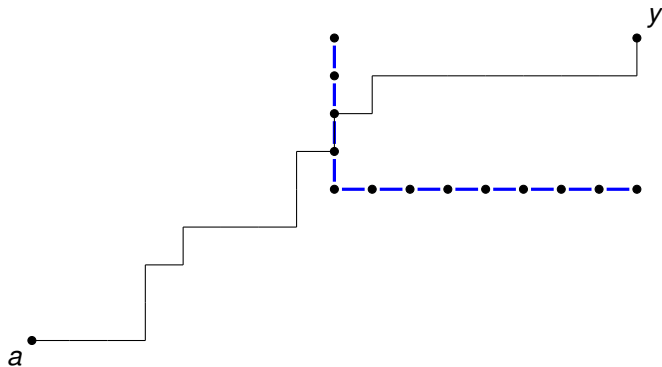

$$I_x = G_{a,x} - G_{a,x-e_1}$$

$$J_x = G_{a,x} - G_{a,x-e_2}$$

Stationary LPP

Replace the boundary to $I \sim \text{Exp}(\varrho)$, $J \sim \text{Exp}(1 - \varrho)$
independent.

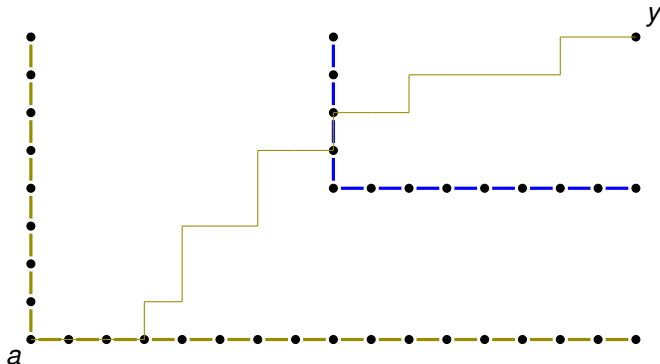

$$I_x = G_{a,x} - G_{a,x-e_1} \quad J_x = G_{a,x} - G_{a,x-e_2}$$

Then $J_x \sim \text{Exp}(\varrho)$, $I_x \sim \text{Exp}(1 - \varrho)$, independent.

Stationary LPP

Replace the boundary to $I \sim \text{Exp}(\varrho)$, $J \sim \text{Exp}(1 - \varrho)$
independent.

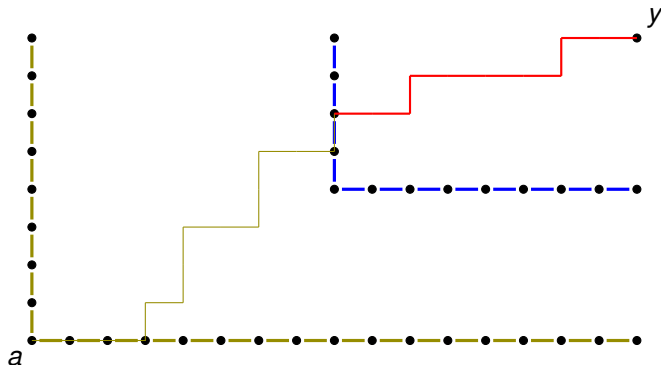

$$I_x = G_{a,x} - G_{a,x-e_1} \quad J_x = G_{a,x} - G_{a,x-e_2}$$

Then $J_x \sim \text{Exp}(\varrho)$, $I_x \sim \text{Exp}(1 - \varrho)$, independent.

The embedded model has the same structure.

Stationary LPP

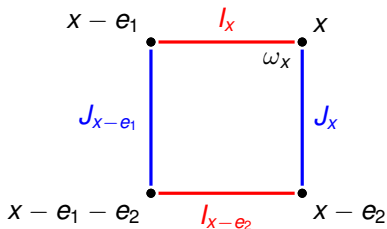

$$I_x = G_{a,x} - G_{a,x-e_1} \quad J_x = G_{a,x} - G_{a,x-e_2}$$

The recursion:

$$G_{a,x} = (G_{a,x-e_1} \vee G_{a,x-e_2}) + \omega_x$$

Stationary LPP

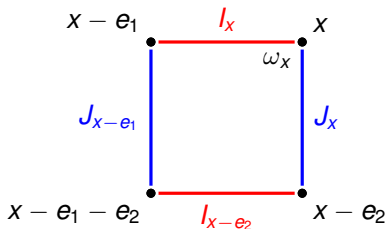

$$I_x = G_{a,x} - G_{a,x-e_1} \quad J_x = G_{a,x} - G_{a,x-e_2}$$

The recursion:

$$G_{a,x} = (G_{a,x-e_1} \vee G_{a,x-e_2}) + \omega_x$$

$$G_{a,x} - G_{a,x-e_1} = (G_{a,x-e_2} - G_{a,x-e_1})^+ + \omega_x$$

Stationary LPP

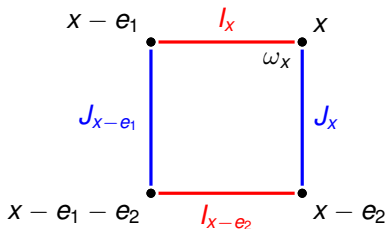

$$I_x = G_{a,x} - G_{a,x-e_1} \quad J_x = G_{a,x} - G_{a,x-e_2}$$

The recursion:

$$\begin{aligned} G_{a,x} &= (G_{a,x-e_1} \vee G_{a,x-e_2}) + \omega_x \\ G_{a,x} - G_{a,x-e_1} &= (G_{a,x-e_2} - G_{a,x-e_1})^+ + \omega_x \\ I_x &= (I_{x-e_2} - J_{x-e_1})^+ + \omega_x \end{aligned}$$

Stationary LPP

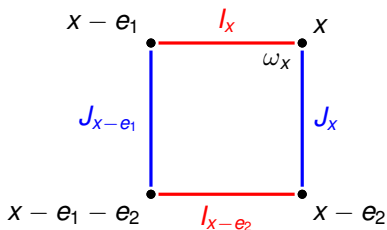

$$I_x = G_{a,x} - G_{a,x-e_1} \quad J_x = G_{a,x} - G_{a,x-e_2}$$

The recursion:

$$\begin{aligned} G_{a,x} &= (G_{a,x-e_1} \vee G_{a,x-e_2}) + \omega_x \\ G_{a,x} - G_{a,x-e_1} &= (G_{a,x-e_2} - G_{a,x-e_1})^+ + \omega_x \\ I_x &= (I_{x-e_2} - J_{x-e_1})^+ + \omega_x \\ J_x &= (J_{x-e_1} - I_{x-e_2})^+ + \omega_x. \end{aligned}$$

Stationary LPP

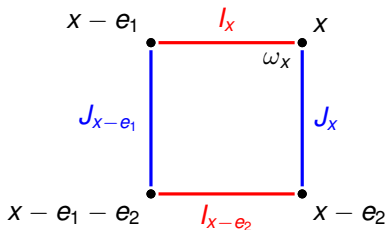

$$I_x = (I_{x-e_2} - J_{x-e_1})^+ + \omega_x \quad J_x = (J_{x-e_1} - I_{x-e_2})^+ + \omega_x$$

Stationary LPP

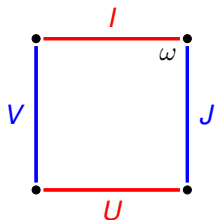

$$I = (U - V)^+ + \omega \quad J = (V - U)^+ + \omega$$

Stationary LPP

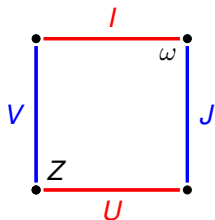

$$I = (U - V)^+ + \omega \quad J = (V - U)^+ + \omega$$

Proposition

$$\left. \begin{array}{l} U \sim \text{Exp}(1 - \varrho), \\ V \sim \text{Exp}(\varrho), \\ \omega \sim \text{Exp}(1), \end{array} \right\} \text{indep.} \quad \Rightarrow \quad \left. \begin{array}{l} I \sim \text{Exp}(1 - \varrho), \\ J \sim \text{Exp}(\varrho), \\ Z := U \wedge V \sim \text{Exp}(1), \end{array} \right\} \text{indep.}$$

Stationary LPP

$$I = (U - V)^+ + \omega \quad J = (V - U)^+ + \omega \quad Z := U \wedge V$$

$$\left. \begin{array}{l} U \sim \text{Exp}(1 - \rho), \\ V \sim \text{Exp}(\rho), \\ \omega \sim \text{Exp}(1), \end{array} \right\} \text{indep.} \Rightarrow \left. \begin{array}{l} I \sim \text{Exp}(1 - \rho), \\ J \sim \text{Exp}(\rho), \\ Z \sim \text{Exp}(1), \end{array} \right\} \text{indep.}$$

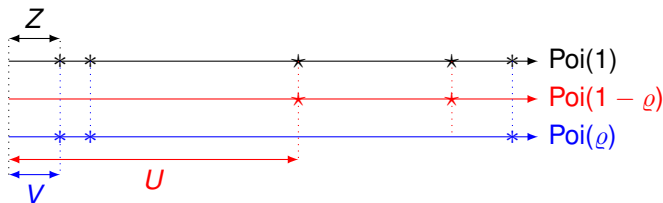

$U - V$ and Z are independent.

Stationary LPP

$$I = (U - V)^+ + \omega \quad J = (V - U)^+ + \omega \quad Z := U \wedge V$$

$$\left. \begin{array}{l} U \sim \text{Exp}(1 - \rho), \\ V \sim \text{Exp}(\rho), \\ \omega \sim \text{Exp}(1), \end{array} \right\} \text{indep.} \quad \Rightarrow \quad \left. \begin{array}{l} I \sim \text{Exp}(1 - \rho), \\ J \sim \text{Exp}(\rho), \\ Z \sim \text{Exp}(1), \end{array} \right\} \text{indep.}$$

$U - V$ and Z are independent.

Stationary LPP

$$I = (U - V)^+ + \omega \quad J = (V - U)^+ + \omega \quad Z := U \wedge V$$

$$\left. \begin{array}{l} U \sim \text{Exp}(1 - \rho), \\ V \sim \text{Exp}(\rho), \\ \omega \sim \text{Exp}(1), \end{array} \right\} \text{indep.} \Rightarrow \left. \begin{array}{l} I \sim \text{Exp}(1 - \rho), \\ J \sim \text{Exp}(\rho), \\ Z \sim \text{Exp}(1), \end{array} \right\} \text{indep.}$$

$U - V$ and Z are independent.

$$(\omega, (U - V), Z) \stackrel{d}{=} (Z, (U - V), \omega)$$

Stationary LPP

$$I = (U - V)^+ + \omega \quad J = (V - U)^+ + \omega \quad Z := U \wedge V$$

$$\left. \begin{array}{l} U \sim \text{Exp}(1 - \rho), \\ V \sim \text{Exp}(\rho), \\ \omega \sim \text{Exp}(1), \end{array} \right\} \text{indep.} \Rightarrow \left. \begin{array}{l} I \sim \text{Exp}(1 - \rho), \\ J \sim \text{Exp}(\rho), \\ Z \sim \text{Exp}(1), \end{array} \right\} \text{indep.}$$

$U - V$ and Z are independent.

$$(\omega, (U - V), Z) \stackrel{d}{=} (Z, (U - V), \omega)$$

Hence

$$\begin{aligned} & ((U - V)^+ + \omega, (V - U)^+ + \omega, Z) \\ & \stackrel{d}{=} ((U - V)^+ + Z, (V - U)^+ + Z, \omega) \end{aligned}$$

Stationary LPP

$$I = (U - V)^+ + \omega \quad J = (V - U)^+ + \omega \quad Z := U \wedge V$$

$$\left. \begin{array}{l} U \sim \text{Exp}(1 - \rho), \\ V \sim \text{Exp}(\rho), \\ \omega \sim \text{Exp}(1), \end{array} \right\} \text{indep.} \Rightarrow \left. \begin{array}{l} I \sim \text{Exp}(1 - \rho), \\ J \sim \text{Exp}(\rho), \\ Z \sim \text{Exp}(1), \end{array} \right\} \text{indep.}$$

$U - V$ and Z are independent.

$$(\omega, (U - V), Z) \stackrel{d}{=} (Z, (U - V), \omega)$$

Hence

$$\begin{aligned} (I, J, Z) &= ((U - V)^+ + \omega, (V - U)^+ + \omega, Z) \\ &\stackrel{d}{=} ((U - V)^+ + Z, (V - U)^+ + Z, \omega) \end{aligned}$$

Stationary LPP

$$I = (U - V)^+ + \omega \quad J = (V - U)^+ + \omega \quad Z := U \wedge V$$

$$\left. \begin{array}{l} U \sim \text{Exp}(1 - \rho), \\ V \sim \text{Exp}(\rho), \\ \omega \sim \text{Exp}(1), \end{array} \right\} \text{indep.} \Rightarrow \left. \begin{array}{l} I \sim \text{Exp}(1 - \rho), \\ J \sim \text{Exp}(\rho), \\ Z \sim \text{Exp}(1), \end{array} \right\} \text{indep.}$$

$U - V$ and Z are independent.

$$(\omega, (U - V), Z) \stackrel{d}{=} (Z, (U - V), \omega)$$

Hence

$$\begin{aligned} (I, J, Z) &= ((U - V)^+ + \omega, (V - U)^+ + \omega, Z) \\ &\stackrel{d}{=} ((U - V)^+ + Z, (V - U)^+ + Z, \omega) = (U, V, \omega). \end{aligned}$$



Stationary LPP

Replace the boundary to $I \sim \text{Exp}(\varrho)$, $J \sim \text{Exp}(1 - \varrho)$
independent.

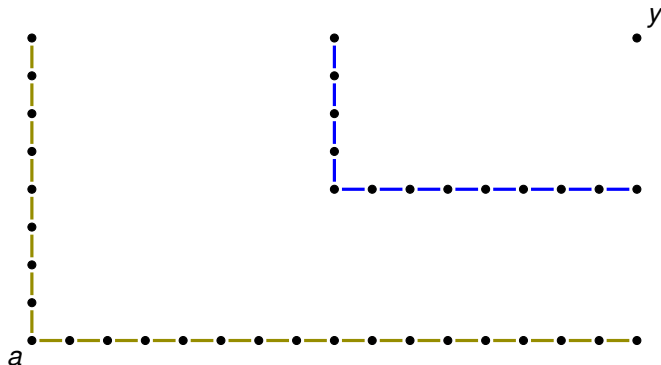

$$I_x = G_{a,x} - G_{a,x-e_1} \quad J_x = G_{a,x} - G_{a,x-e_2}$$

Then $J_x \sim \text{Exp}(\varrho)$, $I_x \sim \text{Exp}(1 - \varrho)$, independent.

The embedded model has the same structure.

Stationary LPP

Replace the boundary to $I \sim \text{Exp}(\rho)$, $J \sim \text{Exp}(1 - \rho)$
independent.

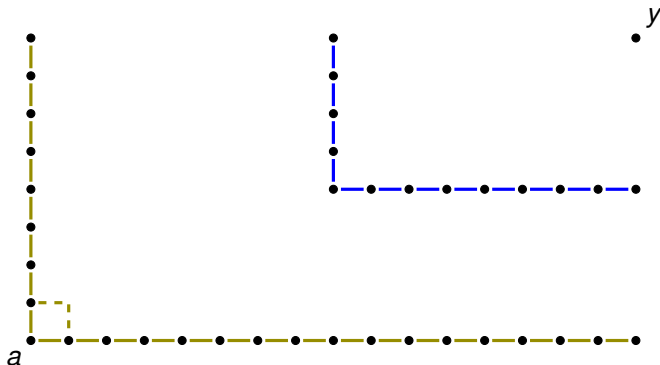

$$I_x = G_{a,x} - G_{a,x-e_1} \quad J_x = G_{a,x} - G_{a,x-e_2}$$

Then $J_x \sim \text{Exp}(\rho)$, $I_x \sim \text{Exp}(1 - \rho)$, independent.

The embedded model has the same structure.

Stationary LPP

Replace the boundary to $I \sim \text{Exp}(\varrho)$, $J \sim \text{Exp}(1 - \varrho)$
independent.

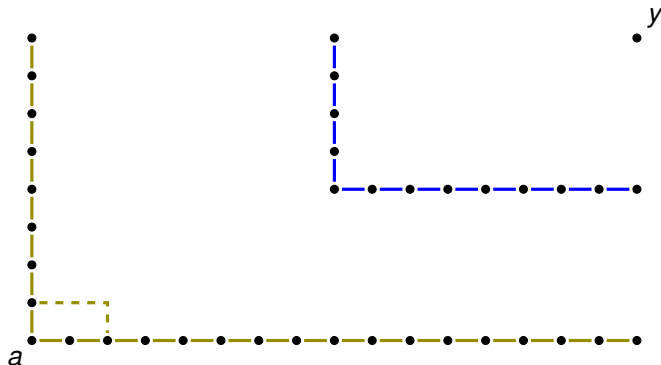

$$I_x = G_{a,x} - G_{a,x-e_1} \quad J_x = G_{a,x} - G_{a,x-e_2}$$

Then $J_x \sim \text{Exp}(\varrho)$, $I_x \sim \text{Exp}(1 - \varrho)$, independent.

The embedded model has the same structure.

Stationary LPP

Replace the boundary to $I \sim \text{Exp}(\varrho)$, $J \sim \text{Exp}(1 - \varrho)$ independent.

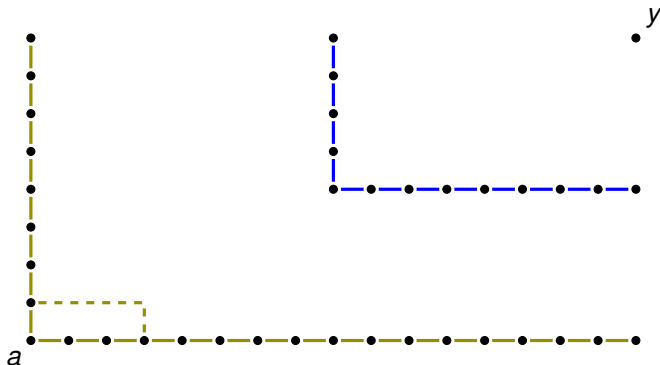

$$I_x = G_{a,x} - G_{a,x-e_1} \quad J_x = G_{a,x} - G_{a,x-e_2}$$

Then $J_x \sim \text{Exp}(\varrho)$, $I_x \sim \text{Exp}(1 - \varrho)$, independent.

The embedded model has the same structure.

Stationary LPP

Replace the boundary to $I \sim \text{Exp}(\varrho)$, $J \sim \text{Exp}(1 - \varrho)$
independent.

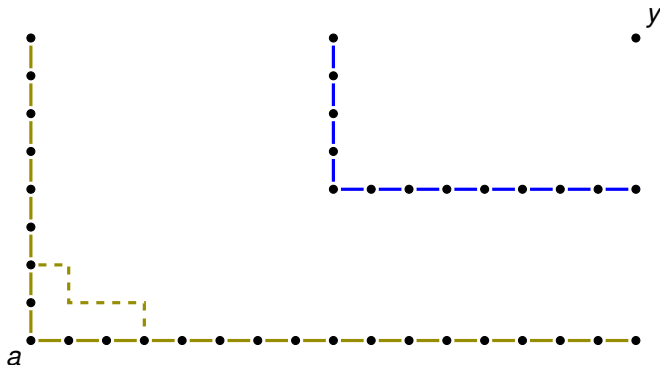

$$I_x = G_{a,x} - G_{a,x-e_1} \quad J_x = G_{a,x} - G_{a,x-e_2}$$

Then $J_x \sim \text{Exp}(\varrho)$, $I_x \sim \text{Exp}(1 - \varrho)$, independent.

The embedded model has the same structure.

Stationary LPP

Replace the boundary to $I \sim \text{Exp}(\varrho)$, $— \sim \text{Exp}(1 - \varrho)$
independent.

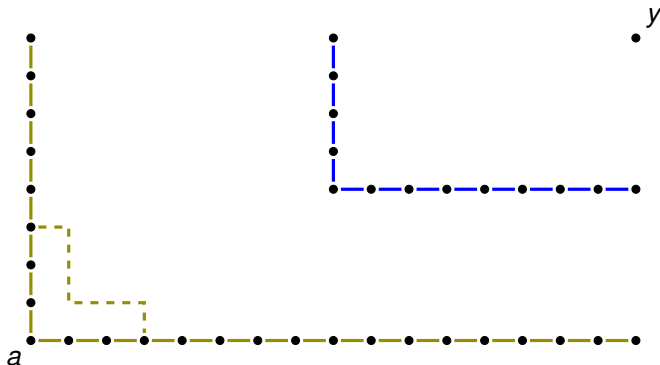

$$I_x = G_{a,x} - G_{a,x-e_1} \quad J_x = G_{a,x} - G_{a,x-e_2}$$

Then $J_x \sim \text{Exp}(\varrho)$, $I_x \sim \text{Exp}(1 - \varrho)$, independent.

The embedded model has the same structure.

Stationary LPP

Replace the boundary to $I \sim \text{Exp}(\varrho)$, $J \sim \text{Exp}(1 - \varrho)$ independent.

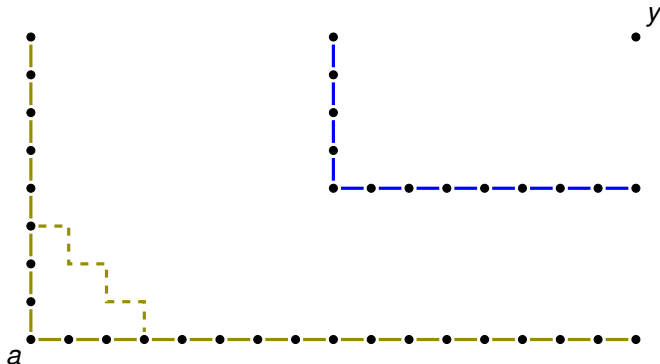

$$I_x = G_{a,x} - G_{a,x-e_1} \quad J_x = G_{a,x} - G_{a,x-e_2}$$

Then $J_x \sim \text{Exp}(\varrho)$, $I_x \sim \text{Exp}(1 - \varrho)$, independent.

The embedded model has the same structure.

Stationary LPP

Replace the boundary to $I \sim \text{Exp}(\varrho)$, $J \sim \text{Exp}(1 - \varrho)$
independent.

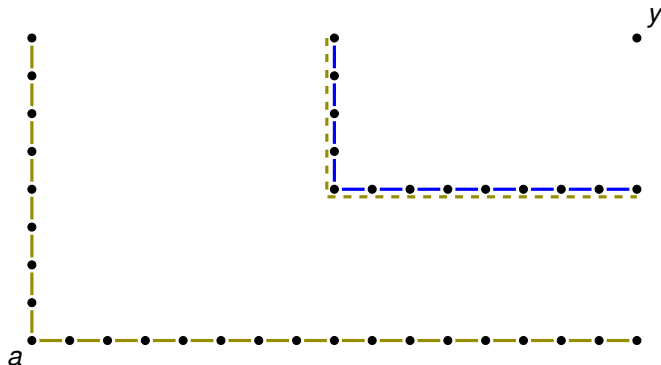

$$I_x = G_{a,x} - G_{a,x-e_1} \quad J_x = G_{a,x} - G_{a,x-e_2}$$

Then $J_x \sim \text{Exp}(\varrho)$, $I_x \sim \text{Exp}(1 - \varrho)$, independent.

The embedded model has the same structure.

Stationary LPP

Replace the boundary to $l \sim \text{Exp}(\varrho)$, $- \sim \text{Exp}(1 - \varrho)$
independent.

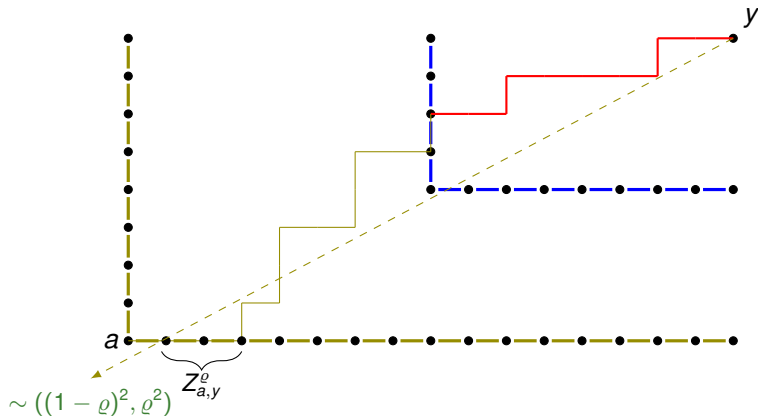

B., Cator, Seppäläinen '06: $\mathbb{P}\{|Z_{a,y}^{\varrho}| \geq \ell\} \leq \text{box}^2/\ell^3$, good directional control.

Infinite geodesics

Even without the boundary:

$J \xrightarrow{a \rightarrow -\infty}$ i.i.d. $\text{Exp}(\varrho)$, $I \xrightarrow{a \rightarrow -\infty}$ i.i.d. $\text{Exp}(1 - \varrho)$, independent.

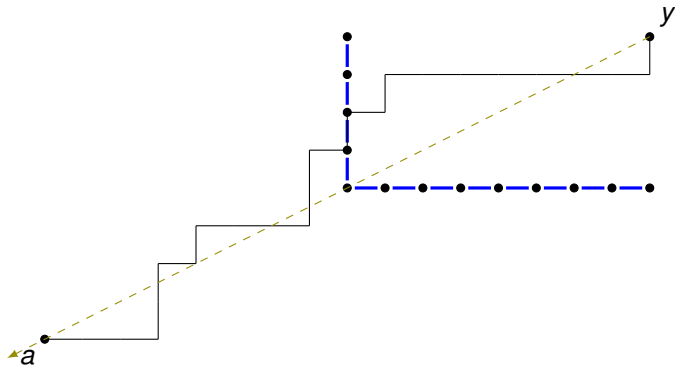

Infinite geodesics

Even without the boundary:

$J \xrightarrow{a \rightarrow -\infty}$ i.i.d. $\text{Exp}(\varrho)$, $I \xrightarrow{a \rightarrow -\infty}$ i.i.d. $\text{Exp}(1 - \varrho)$, independent.

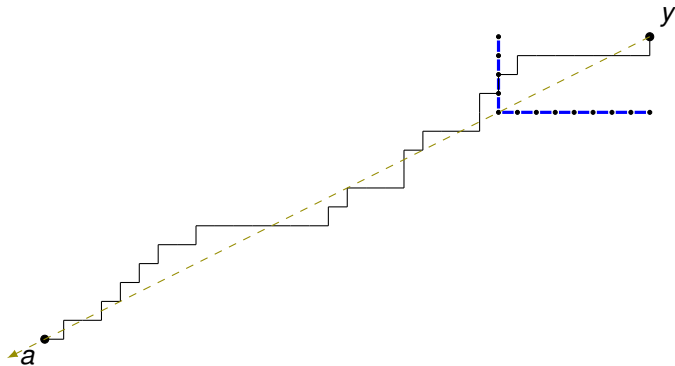

Infinite geodesics

Even without the boundary:

$J \xrightarrow{a \rightarrow -\infty}$ i.i.d. $\text{Exp}(\varrho)$, $I \xrightarrow{a \rightarrow -\infty}$ i.i.d. $\text{Exp}(1 - \varrho)$, independent.

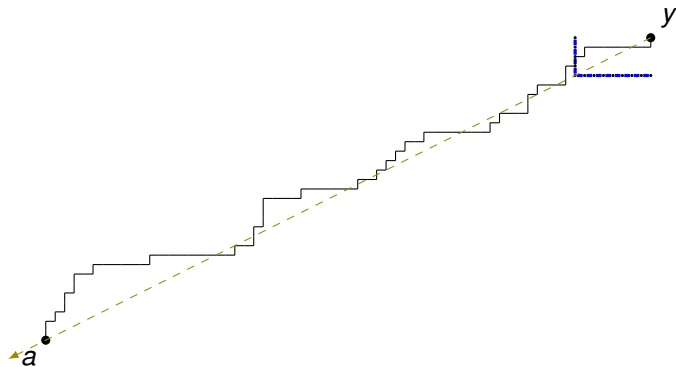

Infinite geodesics

Even without the boundary:

$J \xrightarrow{a \rightarrow -\infty}$ i.i.d. $\text{Exp}(\varrho)$, $I \xrightarrow{a \rightarrow -\infty}$ i.i.d. $\text{Exp}(1 - \varrho)$, independent.

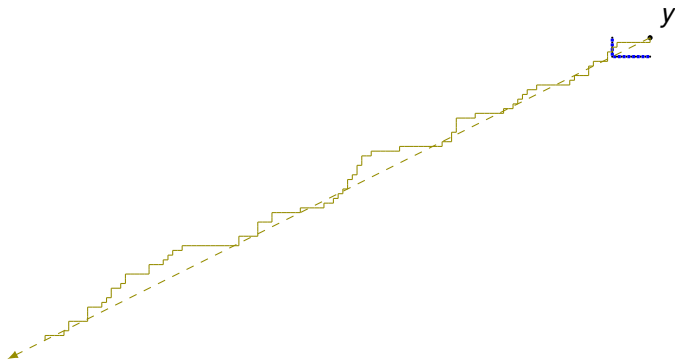

Result 1)

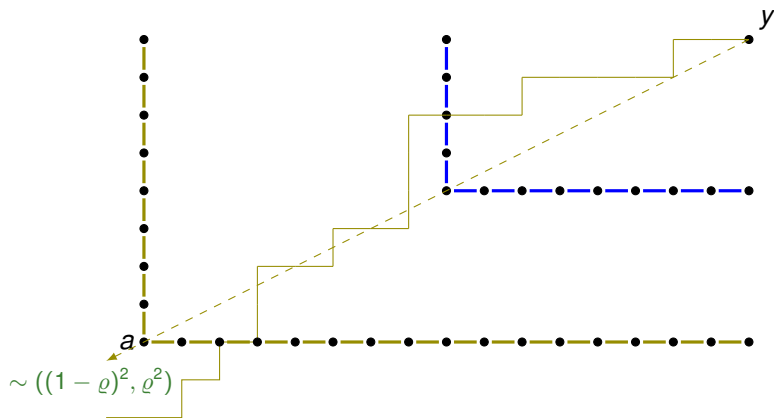

Result 1)

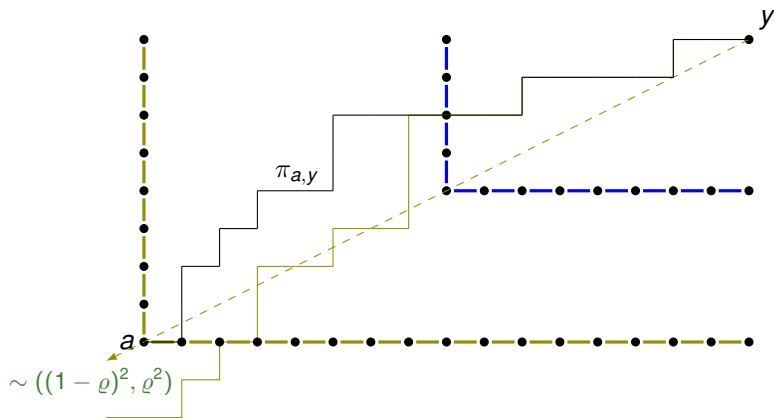

Result 1)

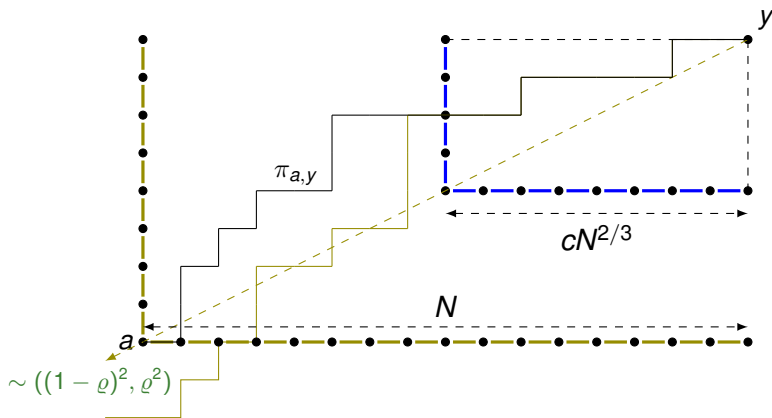

With probability at least $1 - Cc^{\frac{3}{8}}$, stationary and point-to-point paths already coalesce in the small box. (Busani, Ferrari '20)

Result 2)

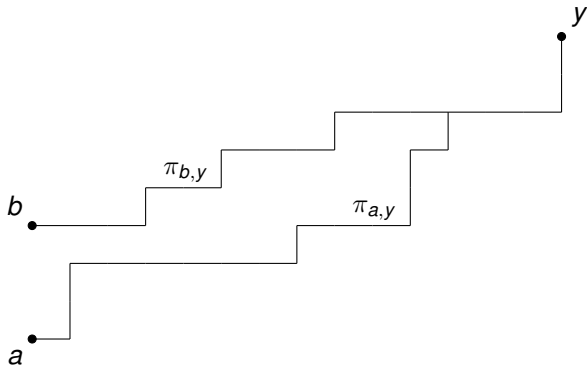

Result 2)

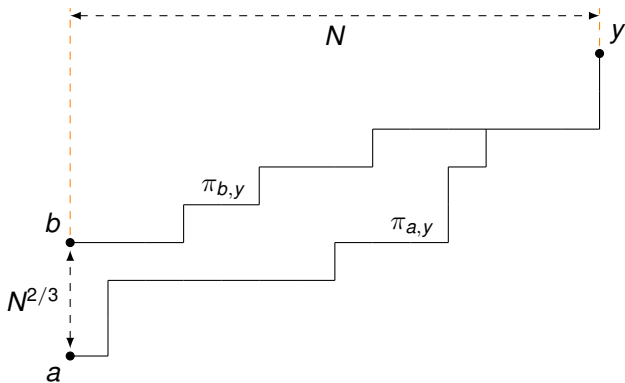

Result 2)

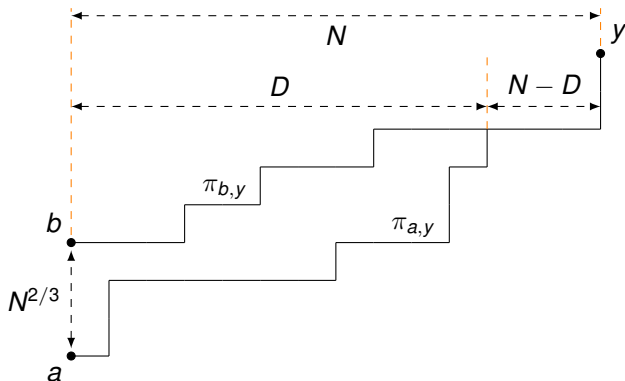

$$\left\{ \begin{array}{l} \mathbf{P}\{D \leq \alpha N\} \leq C\alpha^2, \\ \mathbf{P}\{N - D \leq \alpha N\} \leq C\alpha^{\frac{2}{9}}. \end{array} \right\} \text{ (Basu, Sarkar, Sly '19; Zhang '20)}$$

Result 3)

The Airy_2 process minus a parabola is locally well approximated in total variation by Brownian motion.

Queues

What is an i.i.d. $\text{Exp}(\lambda)$ boundary?

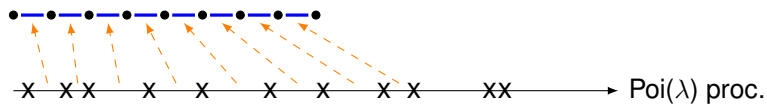

Queues

What is also an i.i.d. $\text{Exp}(\lambda)$ boundary?

x x x x x x x x x x \rightarrow Poi(λ) pr.

Queues

What is also an i.i.d. $\text{Exp}(\lambda)$ boundary?

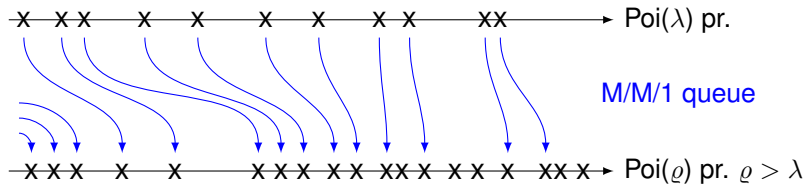

Queues

What is also an i.i.d. $\text{Exp}(\lambda)$ boundary?

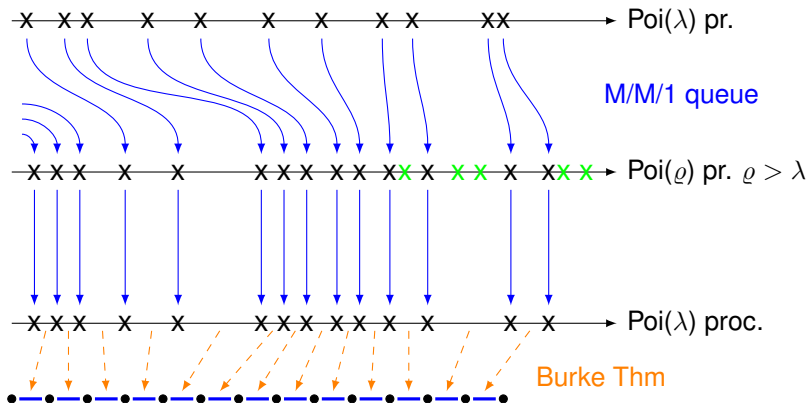

Queues

What is also an i.i.d. $\text{Exp}(\lambda)$ boundary?

What is an i.i.d. $\text{Exp}(\varrho)$ boundary?

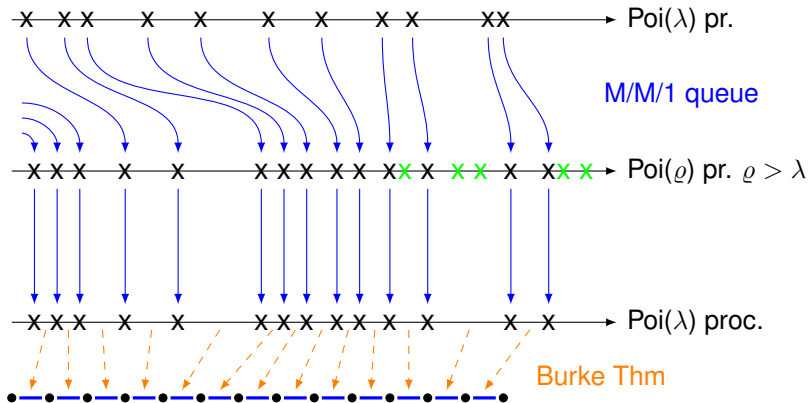

Queues

What is also an i.i.d. $\text{Exp}(\lambda)$ boundary?

What is an i.i.d. $\text{Exp}(\varrho)$ boundary?

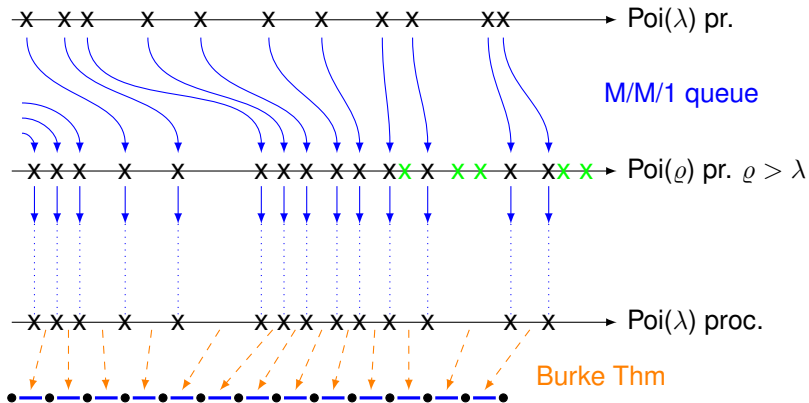

Queues

What is also an i.i.d. $\text{Exp}(\lambda)$ boundary?

What is an i.i.d. $\text{Exp}(\varrho)$ boundary?

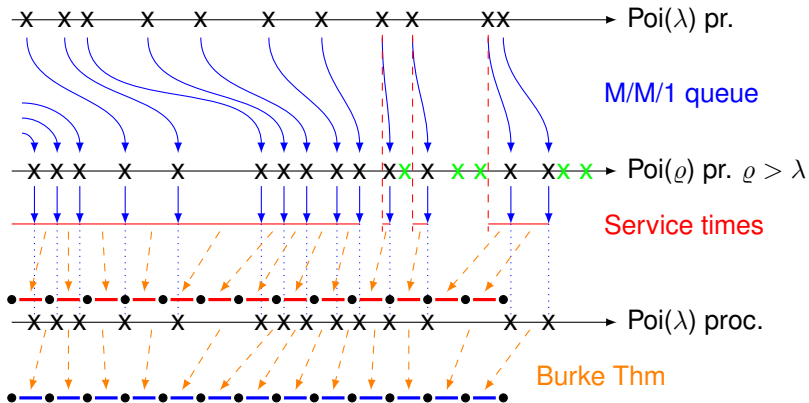

Queues

What is also an i.i.d. $\text{Exp}(\lambda)$ boundary?

What is an i.i.d. $\text{Exp}(\varrho)$ boundary?

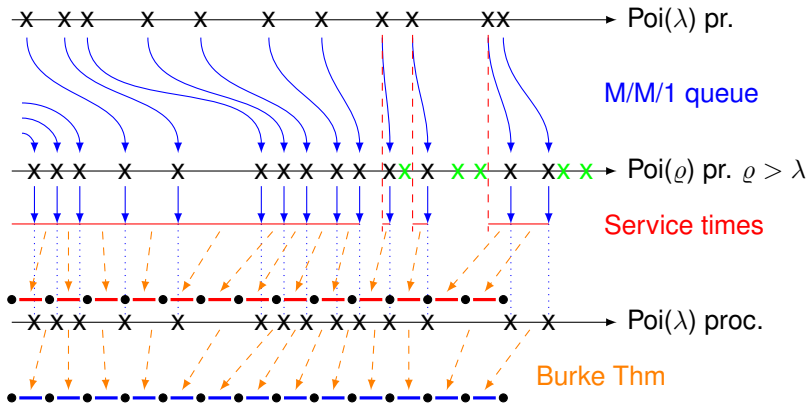

These two boundaries are **jointly** stationary;

(Ferrari, Martin '06; Fan, Seppäläinen '20)

Queues

What is also an i.i.d. $\text{Exp}(\lambda)$ boundary?

What is an i.i.d. $\text{Exp}(\varrho)$ boundary?

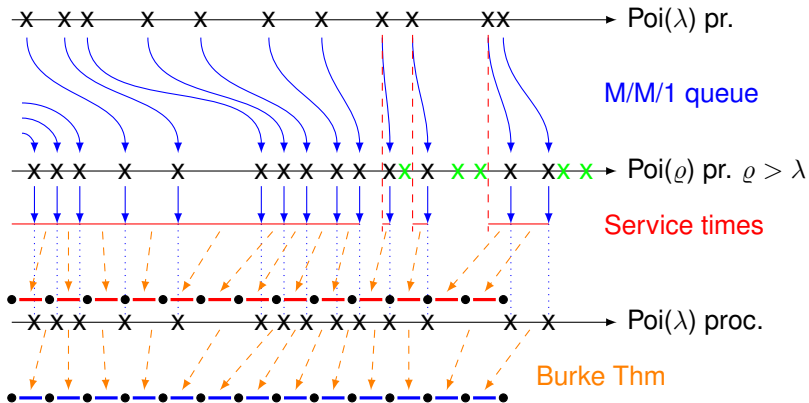

These two boundaries are **jointly** stationary; only differ when the queue empties. (Ferrari, Martin '06; Fan, Seppäläinen '20)

Queues

What is also an i.i.d. $\text{Exp}(\lambda)$ boundary?

What is an i.i.d. $\text{Exp}(\varrho)$ boundary?

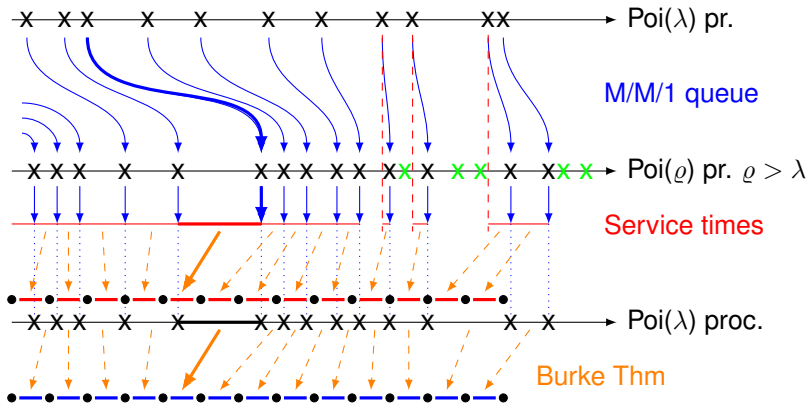

These two boundaries are **jointly** stationary; only differ when the queue empties. (Ferrari, Martin '06; Fan, Seppäläinen '20)

Queues

What is also an i.i.d. $\text{Exp}(\lambda)$ boundary?

What is an i.i.d. $\text{Exp}(\varrho)$ boundary?

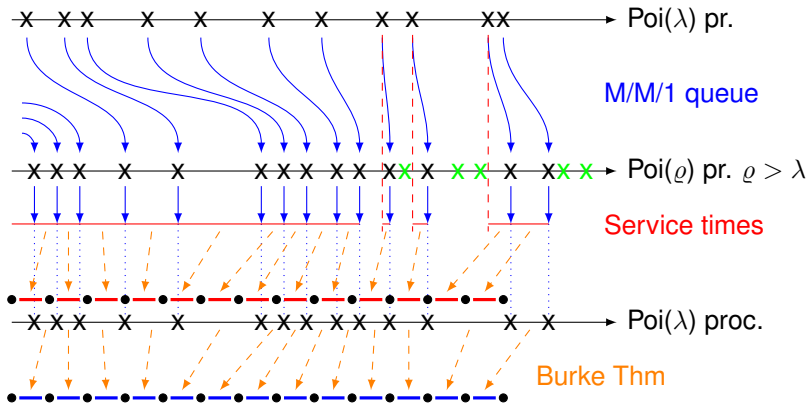

These two boundaries are **jointly** stationary; only differ when the queue empties. (Ferrari, Martin '06; Fan, Seppäläinen '20)

Queues

What is also an i.i.d. $\text{Exp}(\lambda)$ boundary?

What is an i.i.d. $\text{Exp}(\varrho)$ boundary?

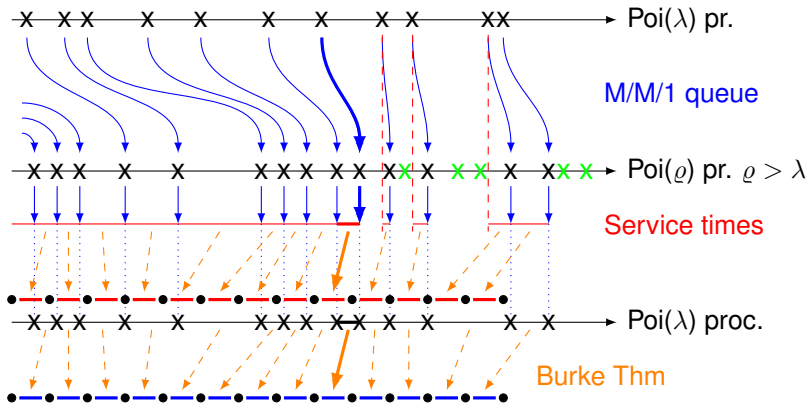

These two boundaries are **jointly** stationary; only differ when the queue empties. (Ferrari, Martin '06; Fan, Seppäläinen '20)

Queues

What is also an i.i.d. $\text{Exp}(\lambda)$ boundary?

What is an i.i.d. $\text{Exp}(\varrho)$ boundary?

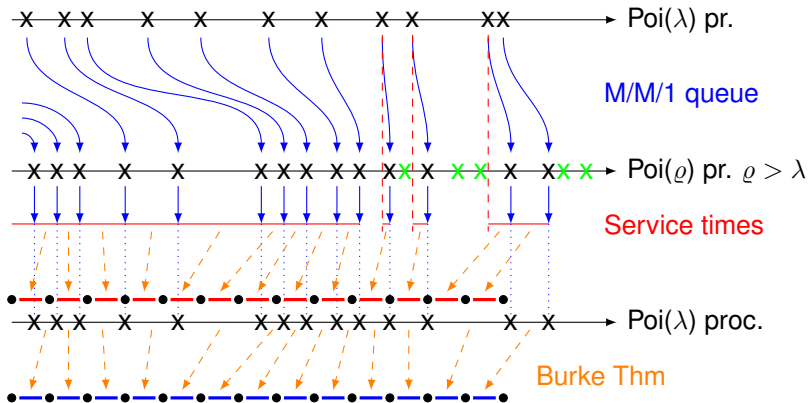

These two boundaries are **jointly** stationary; only differ when the queue empties. (Ferrari, Martin '06; Fan, Seppäläinen '20)

Queues

What is also an i.i.d. $\text{Exp}(\lambda)$ boundary?

What is an i.i.d. $\text{Exp}(\varrho)$ boundary?

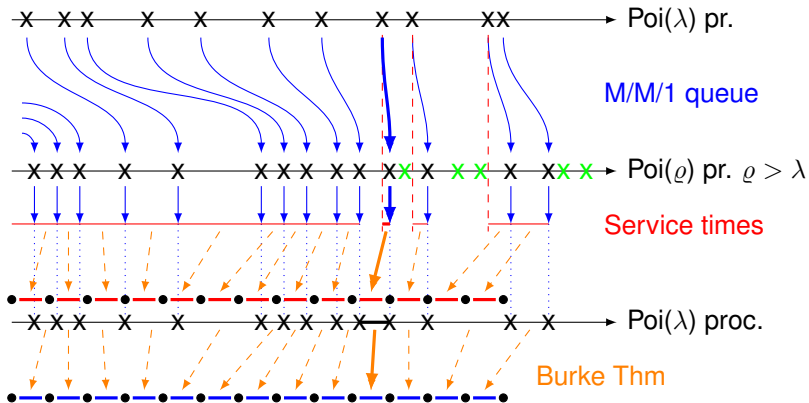

These two boundaries are **jointly** stationary; only differ when the queue empties. (Ferrari, Martin '06; Fan, Seppäläinen '20)

Queues

What is also an i.i.d. $\text{Exp}(\lambda)$ boundary?

What is an i.i.d. $\text{Exp}(\varrho)$ boundary?

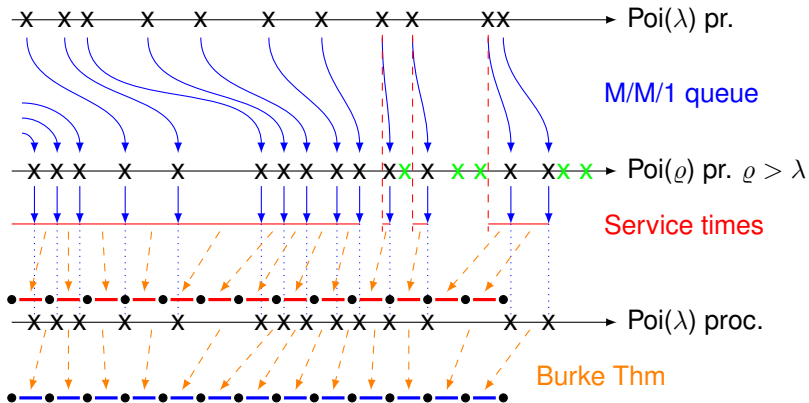

These two boundaries are **jointly** stationary; only differ when the queue empties. (Ferrari, Martin '06; Fan, Seppäläinen '20)

Queues

What is also an i.i.d. $\text{Exp}(\lambda)$ boundary?

What is an i.i.d. $\text{Exp}(\varrho)$ boundary?

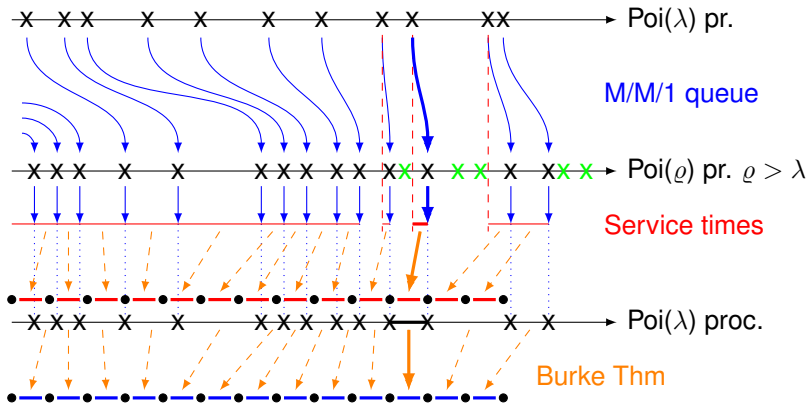

These two boundaries are **jointly** stationary; only differ when the queue empties. (Ferrari, Martin '06; Fan, Seppäläinen '20)

Queues

What is also an i.i.d. $\text{Exp}(\lambda)$ boundary?

What is an i.i.d. $\text{Exp}(\varrho)$ boundary?

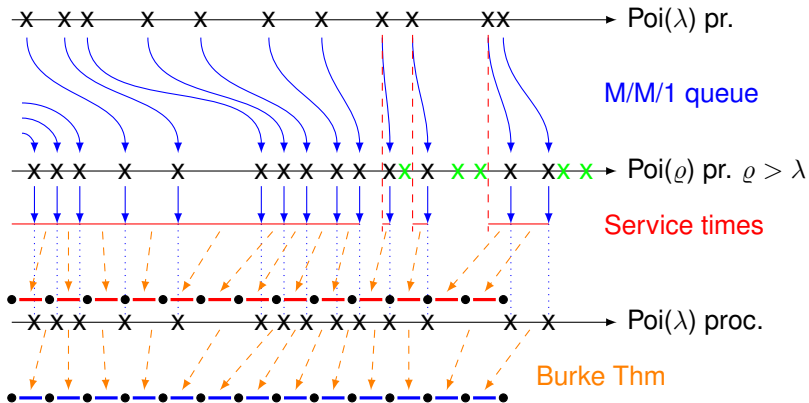

These two boundaries are **jointly** stationary; only differ when the queue empties. (Ferrari, Martin '06; Fan, Seppäläinen '20)

Queues

What is also an i.i.d. $\text{Exp}(\lambda)$ boundary?

What is an i.i.d. $\text{Exp}(\varrho)$ boundary?

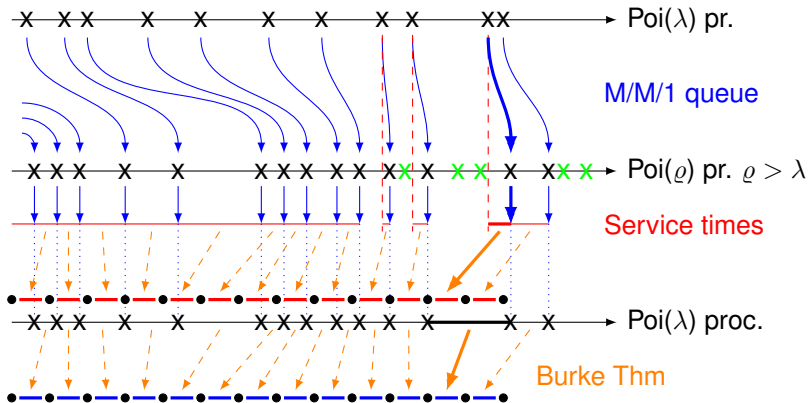

These two boundaries are **jointly** stationary; only differ when the queue empties. (Ferrari, Martin '06; Fan, Seppäläinen '20)

Queues

What is also an i.i.d. $\text{Exp}(\lambda)$ boundary?

What is an i.i.d. $\text{Exp}(\varrho)$ boundary?

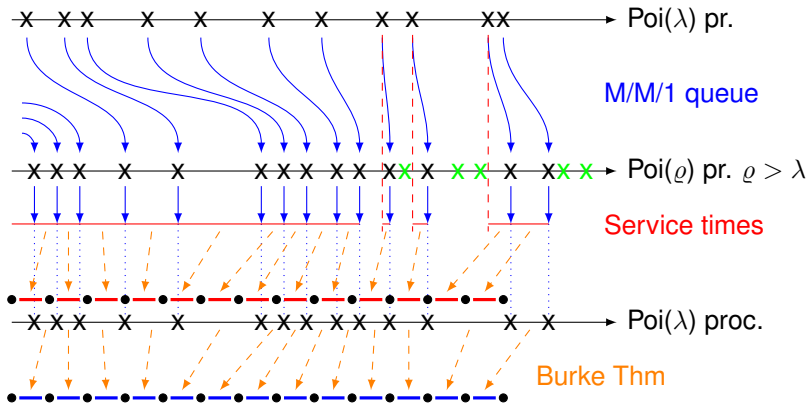

These two boundaries are **jointly** stationary; only differ when the queue empties. (Ferrari, Martin '06; Fan, Seppäläinen '20)

Queues

What is also an i.i.d. $\text{Exp}(\lambda)$ boundary?

What is an i.i.d. $\text{Exp}(\varrho)$ boundary?

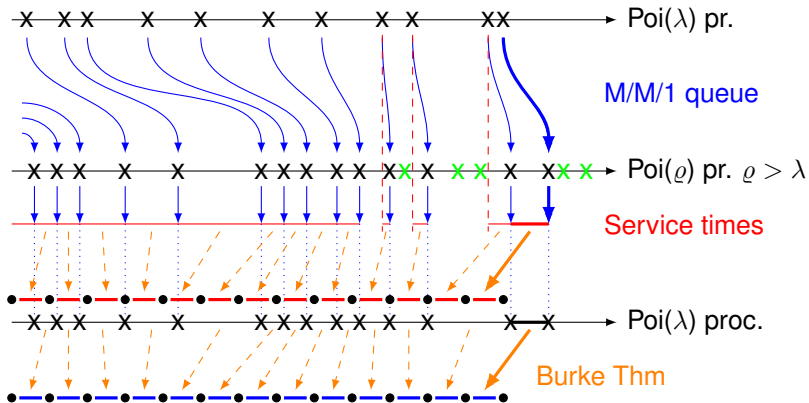

These two boundaries are **jointly** stationary; only differ when the queue empties. (Ferrari, Martin '06; Fan, Seppäläinen '20)

Result 1): P-2-P is like stati path

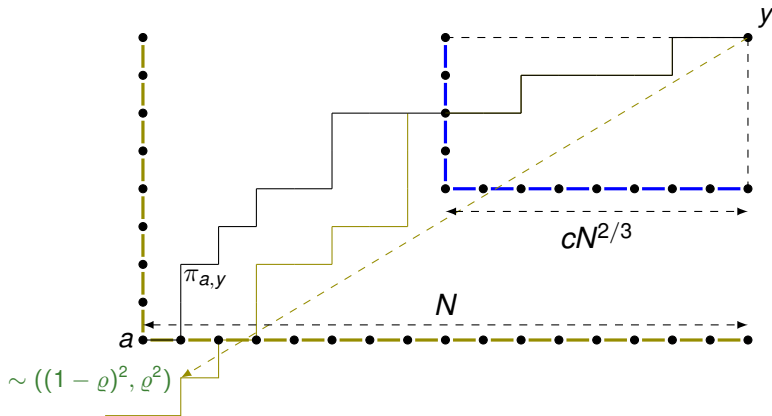

Result 1): P-2-P is like stati path

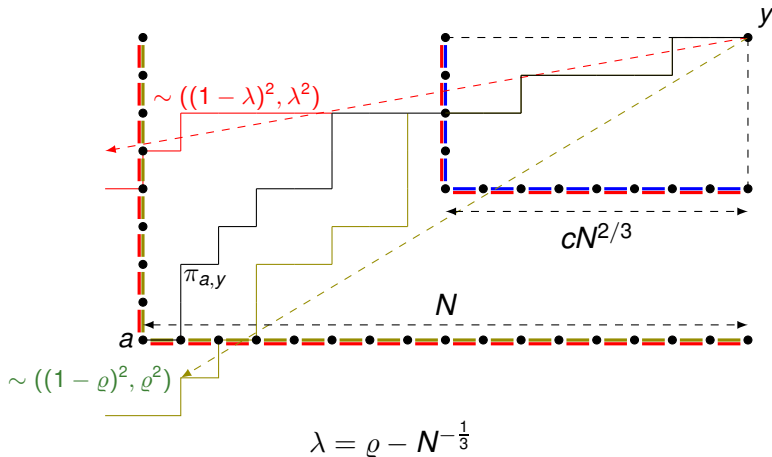

Result 2): P-2-P paths coalesce soon

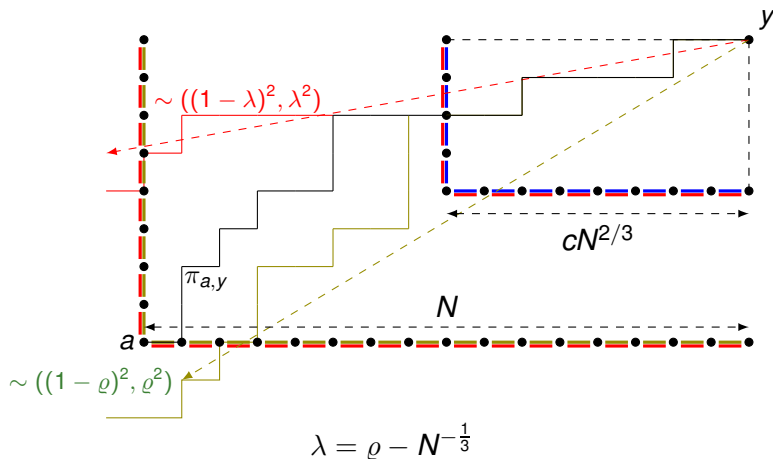

Result 2): P-2-P paths coalesce soon

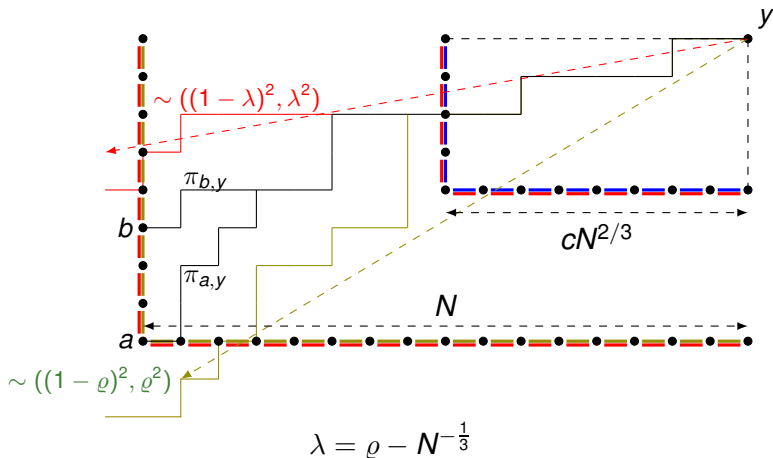

Result 2): P-2-P paths coalesce soon

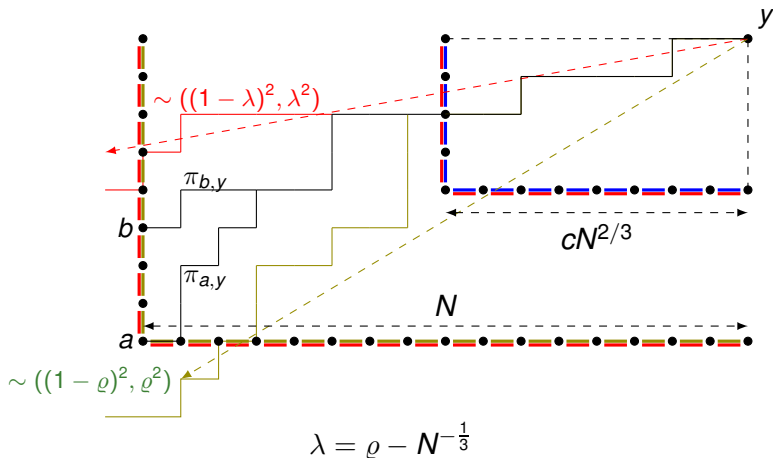

This can be boosted by pulling the small box left by αN .

Result 2): P-2-P paths coalesce soon

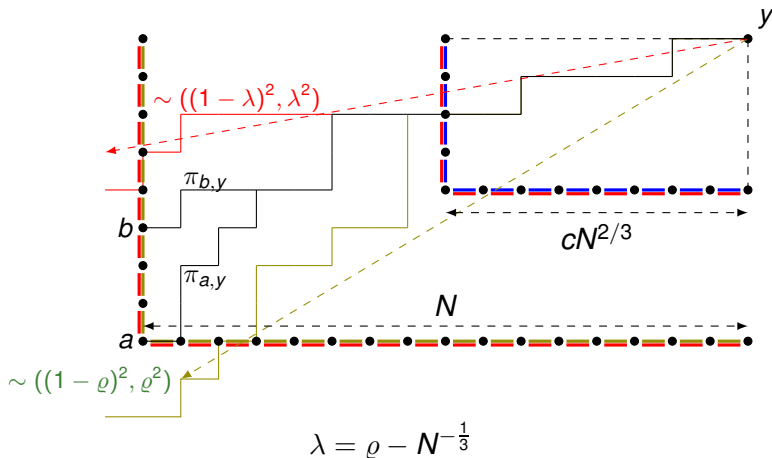

This can be boosted by pulling the small box left by αN .
 Rescale these boundaries: *Stationary Horizon* (Busani'21, +Seppäläinen, Sorensen'22).

Result 2): P-2-P paths don't coalesce soon

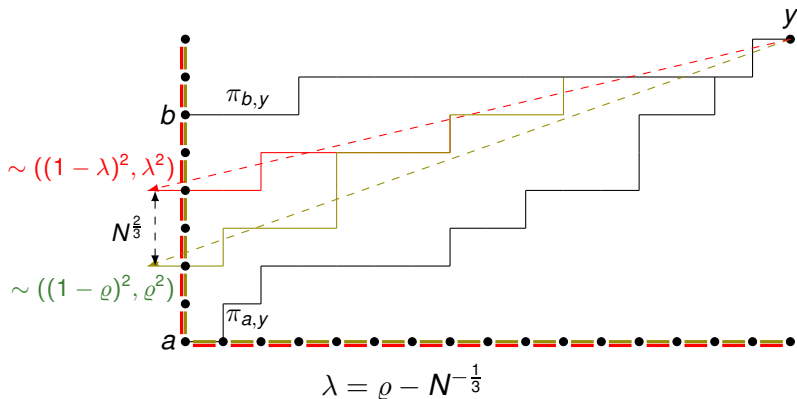

Coalescing too soon would mean stationary paths getting squeezed to each other too soon so they bend.

Result 2): P-2-P paths don't coalesce soon

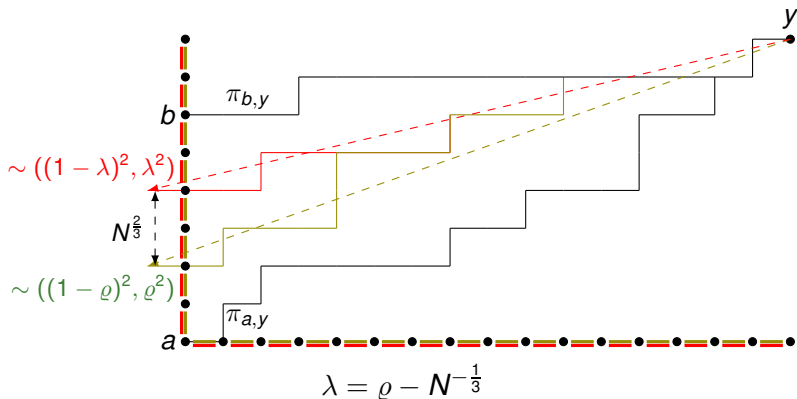

Coalescing too soon would mean stationary paths getting squeezed to each other too soon so they bend.

Thank you.